

GUARDIAN 6000XL™



Operation & Service Manual



TABLE OF CONTENTS

SECTION 1: GENERAL INFORMATION

Introduction	5
Document Icons	5
Naming Convention	6
Dimensions & Specifications	7
Dimensional Drawing	9

SECTION 2: INSTALLATION & SETUP

Unpacking/Installing the Changer	10
Loading Coins	12
Dispensing Coins	13
Setting Par / Float	14

SECTION 3: GENERAL CHANGER OPERATION

Steady State User Display	15
General Changer Operation	15
Menu Navigation	17
Menu Structure	17

SECTION 4: TYPICAL USAGE

Parring the Guardian	19
Setting Par / Float	21
Enabling/Disabling Overfill Paydown	21
Par Paydown	21
Tube Enable	22
Audit Reporting	23
Changing the Payout Coin Tube	24
Configuration	25
Cassette Configuration	27
Eliminating a Slug	28
Adding a Token	29
Deleting a Token	29
Token Change Value	30
Token Change Routing	30

SECTION 5: ADVANCED CONFIGURATION

Password	32
Changing the Password	32
Password Protection Levels	33
Coin Enable	34
Coin Security Level	34
Token Value	34
Dual Currency	35
Change Management	36
Language	37
Clear Historical Audit	37
Disable/Enable Audible Feedback	38

MDB Level	38
MDB Scale Factor	39
MDB Decimal Point	39
Factory Reset	40
Tube Sense	40
Versions	42

SECTION 6: EXECUTIVE CONFIGURATION

Price Holding	44
Max Pricelines	44
Set Pricelines	45
Vending Mode	46
Escrow Return	47
Discount Trigger	47
Discount Award	47
Max Change	48
Max Credit	48
Exact Change Accept Group	49
Exact Change Value	49
Overpay Value	49
Price Display	50
Keep Change	50
Cashless (MDB) Pricelines	50
Protocol A Scaling Factor	51
Set (Cashless) Pricelines	52
Revaluation	53
Bill Validator Accept Group	53
Bill Escrow	54
Set Time	54
Set Date	54
Daylight Saving	55
Executive Audit	56
Audit Peripheral	57
Machine ID	58
Security Code	59
Pass Code	59
Dex Clear	60

SECTION 7: MAINTENANCE

Routine Maintenance	61
Disassembly	61

SECTION 8: TROUBLESHOOTING

Autotest	66
Warning Messages	67
Troubleshooting Matrix	68

This page is intentionally blank

SECTION 1: GENERAL INFORMATION

Introduction

This manual contains information on installing, operating and maintaining a Coinco Guardian 6000XL™ model coin changer. This manual is intended for owners, route operators and shop-level technicians as a primary source of information. Taking time to read this manual and become familiar with the information will help you obtain the best performance from your Coinco Guardian coin changer.

Product Overview and Features

The Guardian 6000XL™ changer incorporates a wide range of benefits, including:

- Six self-replenishing coin tubes with cash accountability.
- Swing-out, illuminated payout cassette.
- Built-in self diagnostics.
- MDB (Multi-Drop Bus) interface (optional MDB to USB converter available).
- Field tuning for tokens & slug elimination.
- Interchangeable coin tubes enable simple payout re-configuration.
- Full support of Guardian features and upgrades using the Coinco FP-5 Field Programmer

For Your Records

A label indicating the changer's model number and serial number can be found on the side of the Guardian coin changer. Refer to the model number and serial number whenever you call your Coinco Service Center for information or service. The first four digits of the changer serial number indicate when the unit was built, which is also the beginning of the warranty period:

- First two digits: indicate the week of manufacture.
- Third and fourth digit: indicate the year.

For example, serial number 1507000123 indicates the unit was manufactured in the 15th week of 2007.

Icons

The following icons will guide you throughout the manual. Each icon highlights an area you may want to pay closer attention to.



Indicates a checklist type of process that you can readily “check” as you proceed to the next step.



Indicates a warning that you should adhere to. It is often accompanied by the words “DO NOT...”



Indicates that this is a good time to pause, step back, and verify that everything is correct before proceeding further.



Indicates a helpful hint or shortcut to simplify the task.



Indicates frequently asked questions with their corresponding answers.



Indicates a possible issue dependent on the application and provides direction on how to correct the problem should it occur.

Guardian 6000XL™ Naming Convention

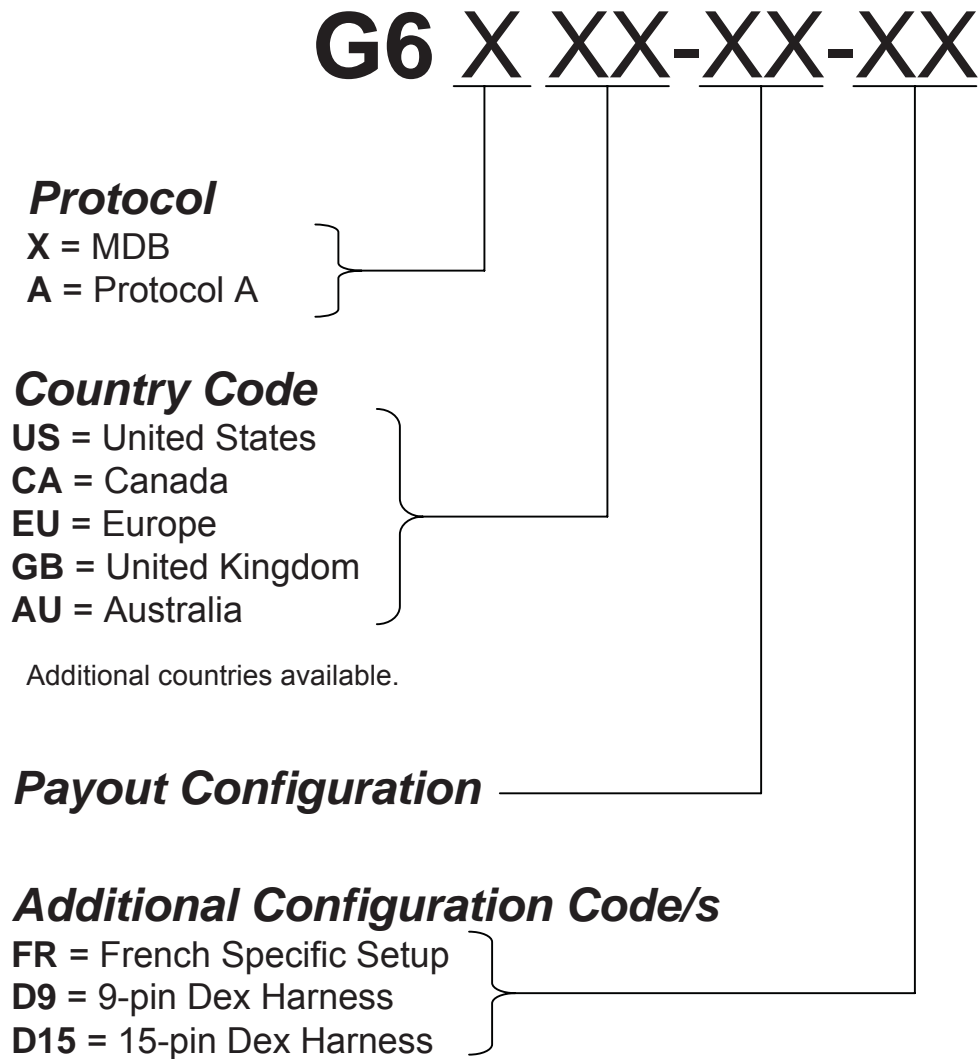

Examples

G6XEU-BB: Guardian 6000XL six tube changer, MDB protocol, “BB” payout configuration (€1 - 20c - 5c - 5c - 10c - 50c), for European market.

G6AGB-DB: Guardian 6000XL six tube changer, Executive (Protocol A) protocol, “DB” payout configuration (10p - 50p - 10p - 5p - 5p - 20p), for UK market.

Dimensions and Specifications

Power Requirements:

MDB: 20 to 42V DC (1.8 Amp max operating)

Executive (Protocol A): 24V AC 50/60Hz (1.8 Amp max operating)

Operating Temperature

0°F to 150°F

-18°C to 65°C

Storage Temperature

-22°F to 160°F

-30°C to 72°C

Relative Humidity

20% to 95% non-condensing

Operating Attitude

Vertical $\pm 3^\circ$

Shipping Weight in Carton

Approximately 5 lbs. or 2.267 kilograms

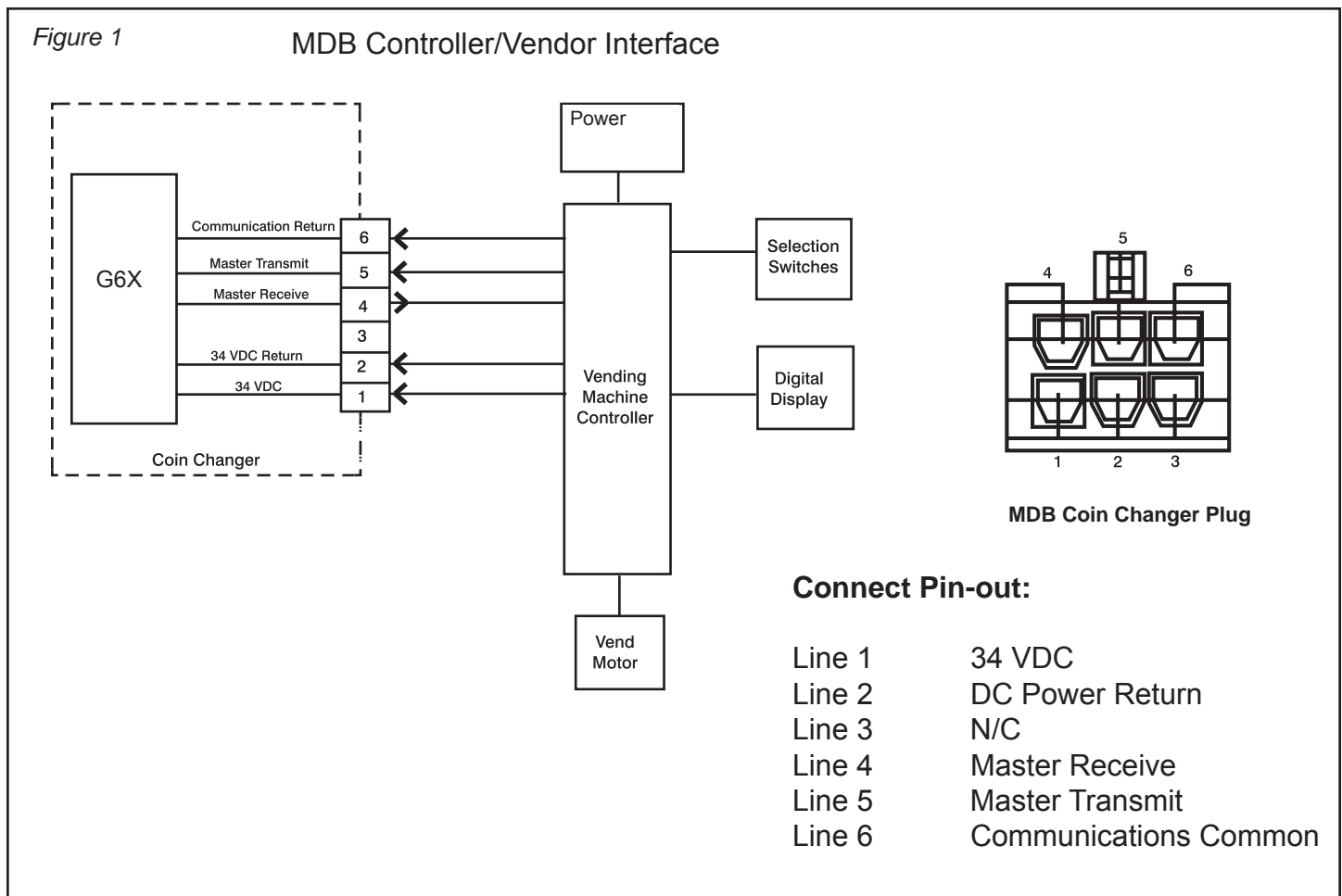
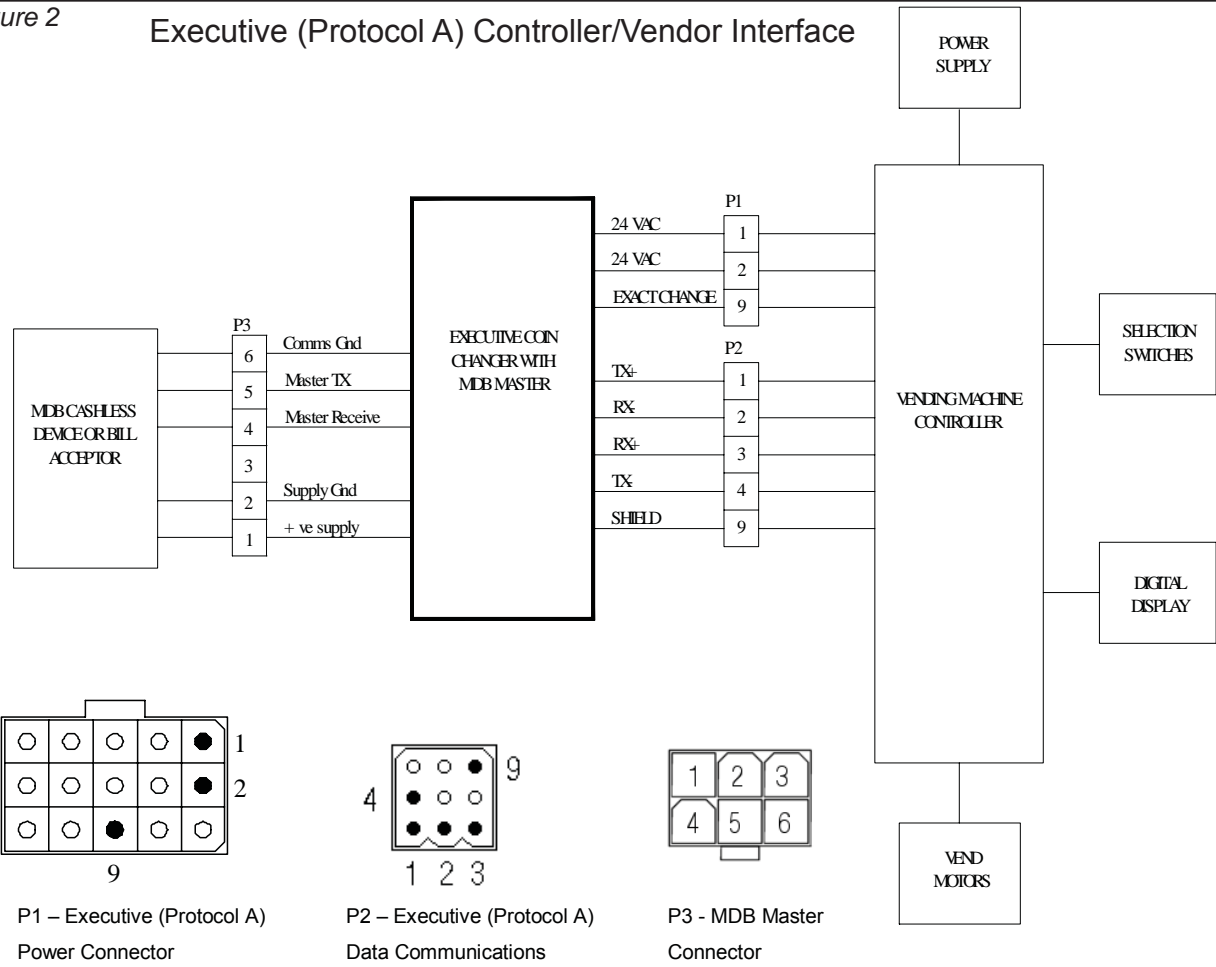

Figure 2

Executive (Protocol A) Controller/Vendor Interface



SECTION 1: GENERAL INFORMATION

Dimensional Drawing inches (mm)

Figure 3

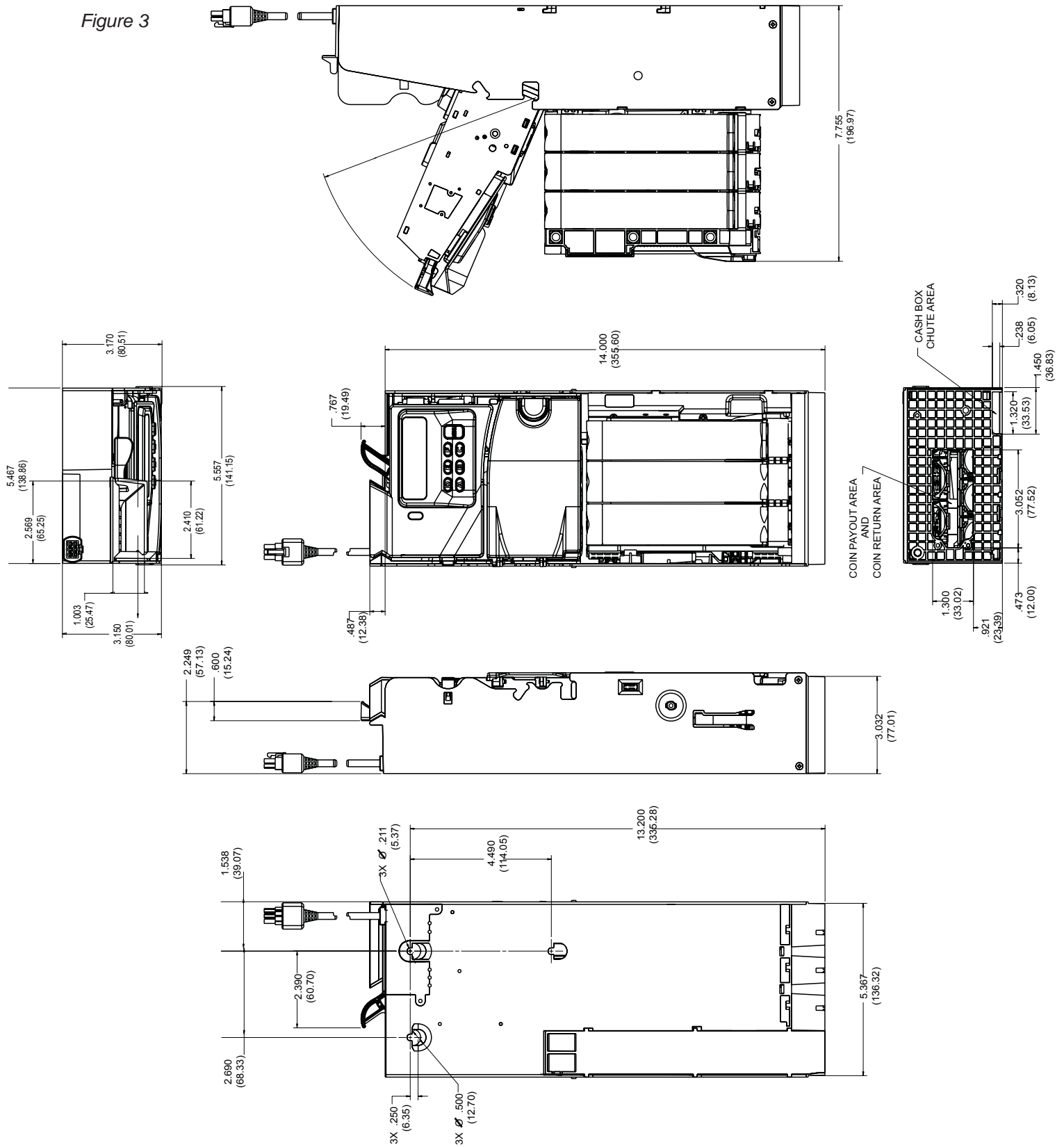

Unpacking / Installing the Changer

After removing the coin changer from the shipping carton, inspect it for possible damage. If the unit is damaged, notify the shipping company immediately. The consignee (person or company receiving the unit) can file a claim against the carrier for shipping damage. We recommend you keep the original carton and packaging materials to reuse if you need to transport or ship the coin changer in the future.

If the coin changer is being stored or used as a spare, always keep it in its shipping carton when not in use. This will keep it clean and offer the best protection for the unit.

Installing the Changer

1. Remove power from the vending machine.
 -  **DO NOT connect the changer harness to the vending machine with power connected.**
2. Remove the acceptor from the changer housing by pressing the acceptor latch (see Figure 5) on the front of the acceptor and pull the escrow lever towards you, away from changer housing.
3. Disconnect the two acceptor cables (see Figure 6). Lift the acceptor slightly to free the lower acceptor studs from the changer.
4. Set the three mounting holes in the back of the changer housing over the mounting screws in the vending machine (see Figure 7). Tighten securely by hand.
5. Re-install the acceptor by inserting the lower acceptor studs into the changer housing. Re-connect the two acceptor cables then press the top of the acceptor into the changer housing until the acceptor latch engages the changer housing.
6. Verify the vendor's coin return mechanism is adjusted so that the Acceptor gate is fully closed. There should be a small gap between the coin return mechanism and the changer escrow lever.

Changer Components

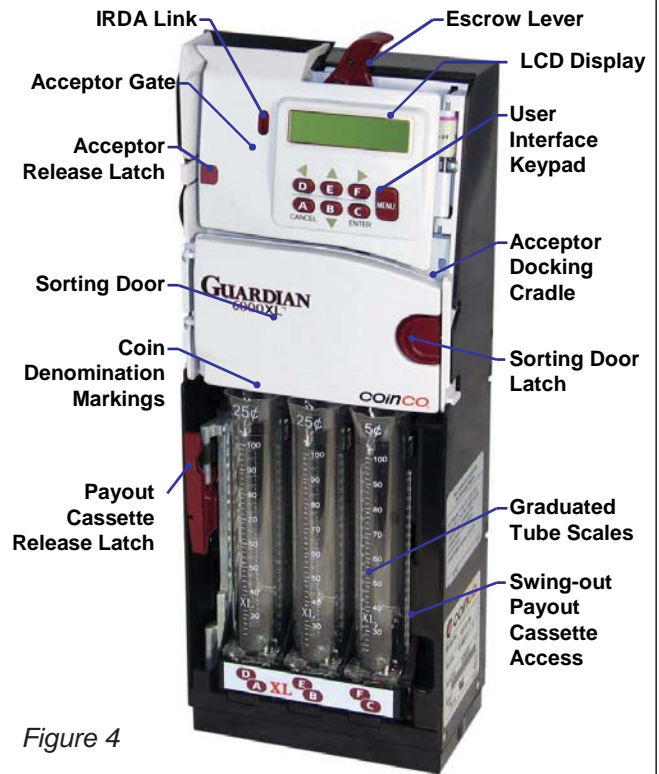

Figure 4

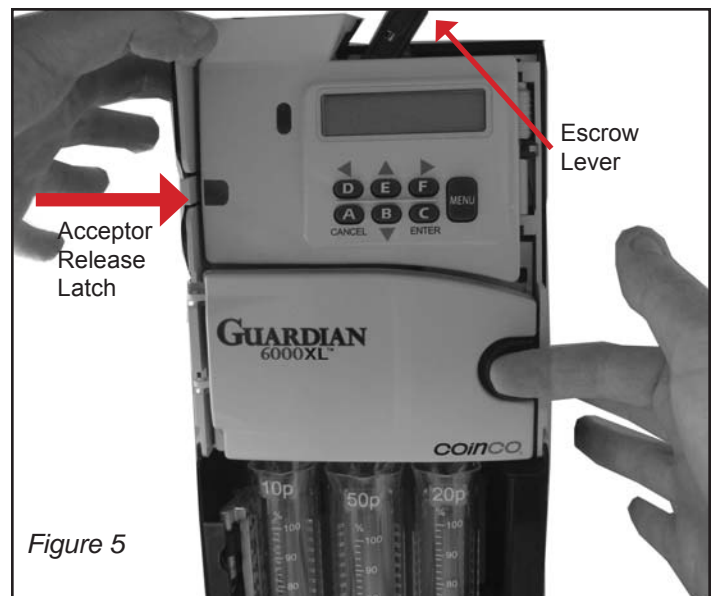
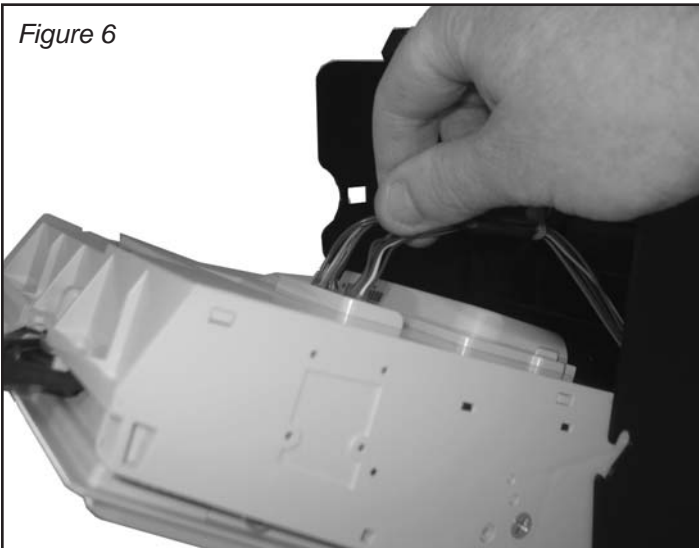

Figure 5

7. Plug the changer harness into the vending machine.
STOP **Verify steps 1 to 7 are completed correctly.**
8. Apply power to the vending machine.
9. The changer will power up, perform an auto-test of all systems, then the display will begin cycling in steady state mode. See Figure 8.

Figure 6



Power Up Sequence

Figure 8 Typical User Display Messaging

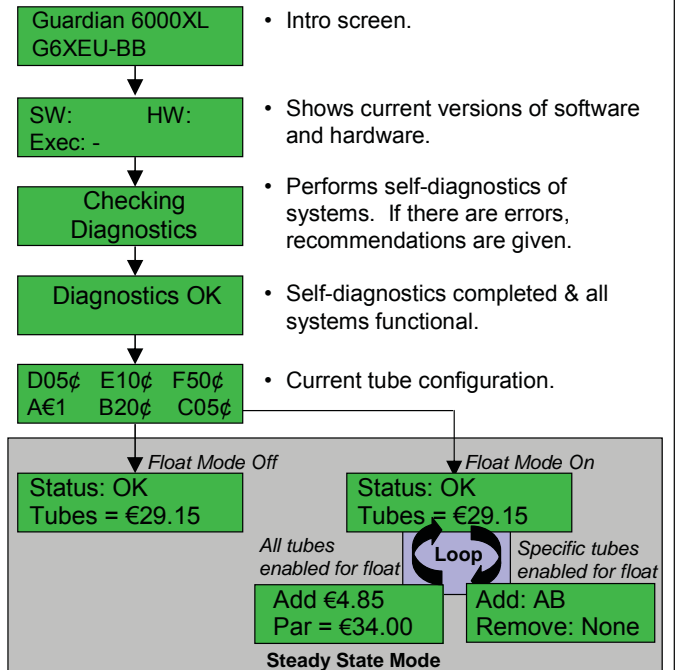

Note: Some Guardian models may show different messaging.

Figure 7

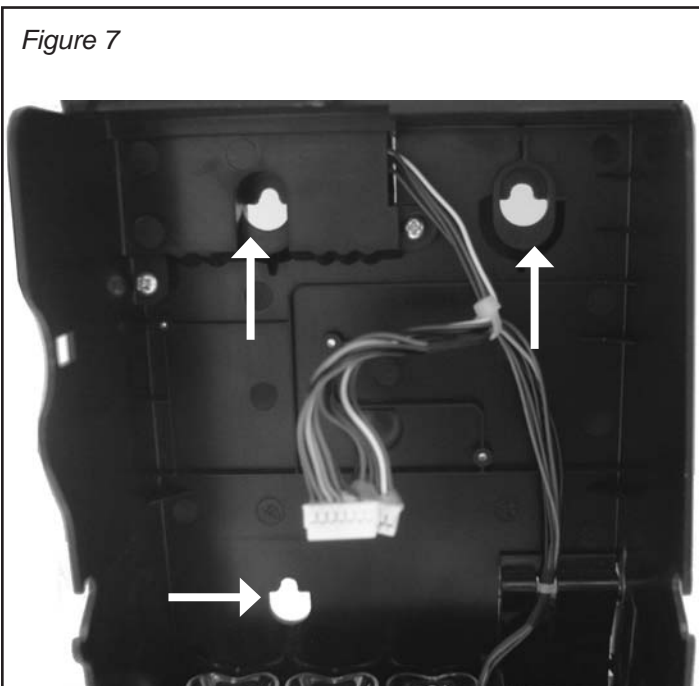

Loading Coins

10. Load coins into the changer the tubes using one of the following 3 options:
- Using Swing Out Payout Cassette:**
 Rotate the Payout Cassette Release Latch downward to open the coin Payout Cassette (See Figure 9). Pivot the Payout Cassette out of the changer housing to access the coin tubes (See Figure 10). Once the latch has been depressed, the Payout Cassette must be at least partially opened before it can be closed and reset properly. Fill the six coin tubes to the desired levels with the appropriate coins. Refer to the individual labels at the top of the tube to determine which coin denominations go in each tube.
 - By Removing Cassette:** The cassette can also be lifted out of the changer for loading coins. Open the Payout Cassette and swing it out, then lift the Payout Cassette straight up to remove it (See Figure 11). Load coins as described above. Reinstall the Payout Cassette by first positioning the lower pin, then align the upper pin lowering the cassette into position. Close the cassette.
 - To Load Front Tubes Only:** Tubes A, B, and C can be hand loaded without opening the cassette. By pushing the Sorting Door Latch to the left and swinging open the Sorting Door (See Figure 12), you can load coins directly in tubes A, B, and C.



NOTES:

- **Make sure all coins lay flat and fill each coin tube to be used with at least 5 coins.**
- **For the most reliable operation, do not load coin tubes above the 100% level marking.**
- **If not using all 6 tubes, leave all tubes installed and make sure to disable coin routing for unused tubes.**
 Use MENU/SETUP/CASSETTE/CUSTOM and set unused tubes to “---”.

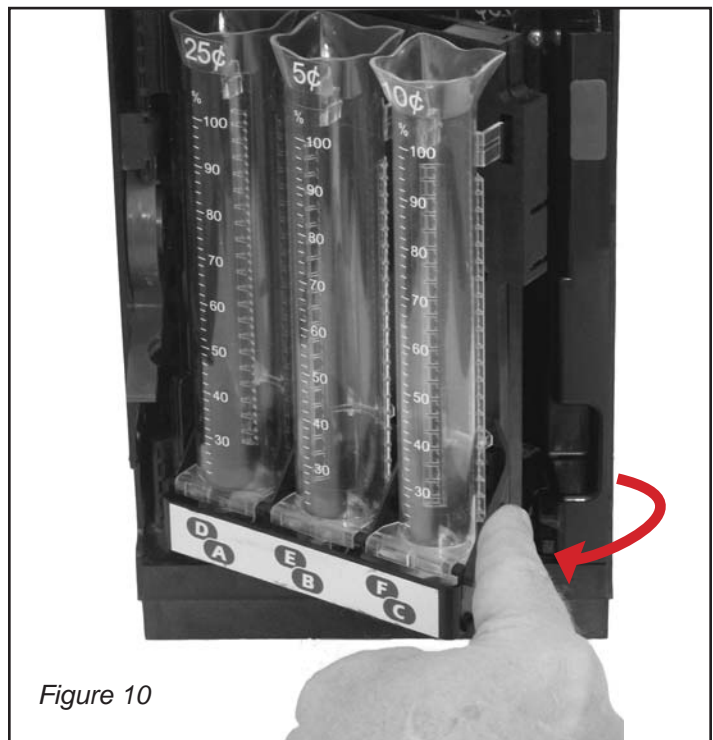
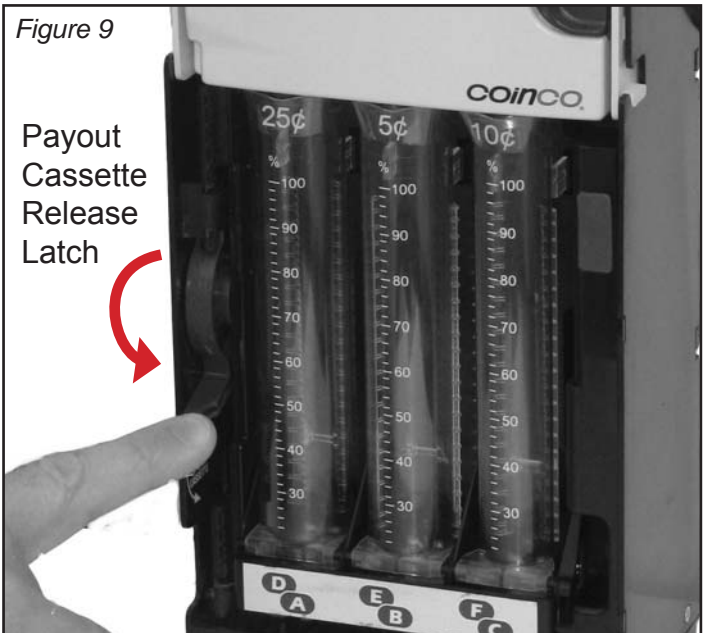

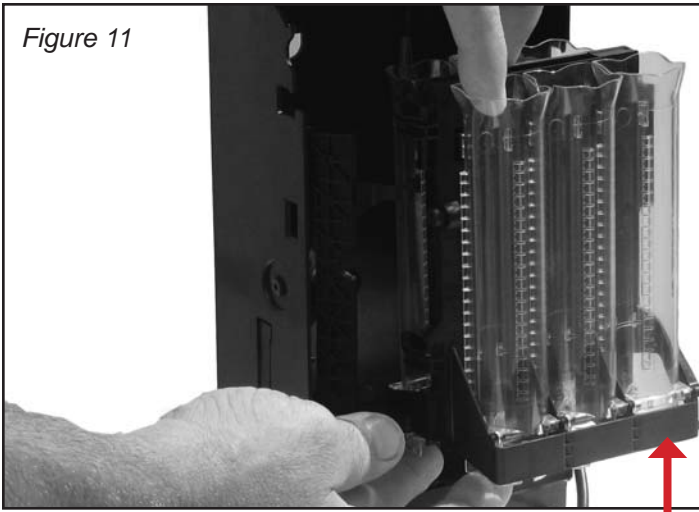

Figure 11



Figure 12

Coin Payout Modes

Manual Payout

Normal Mode	Keystrokes
Payout one or more coins from a tube	Hold down alpha key until desired coins are paid out.

Auto Paydown Mode	Keystrokes
Payout ALL coins in a tube	Hold down alpha key until at least 4 coins are dispensed.
Stop Coin Payout	Press any key.

Note: The last several coins in a tube can be paid out with individual button pushes.

Figure 13

? Does the changer pay out all coins from tubes or leave hidden coins? How are hidden coins reported?

As is typical with most changers, the Guardian leaves some hidden coins per tube (typically 5 per tube) to ensure in coming coins will always stack properly. These coins can be paid out in a manual payout mode. Hidden coins are not reported on MDB and are not available for change making. They are included in audit information and are used in all tube scanning and float/par calculations.

✓ Dispensing Coins

Verify proper payout operation

11. Pay out at least two coins from each tube to ensure proper operation. Press each coin tube Inventory Button (See Figure 14) to dispense coins.
12. Drop a variety of coins into the changer to ensure proper operation.

Basic keypad navigation is shown in Figure 14 and a coin payout mode summary in Figure 13.

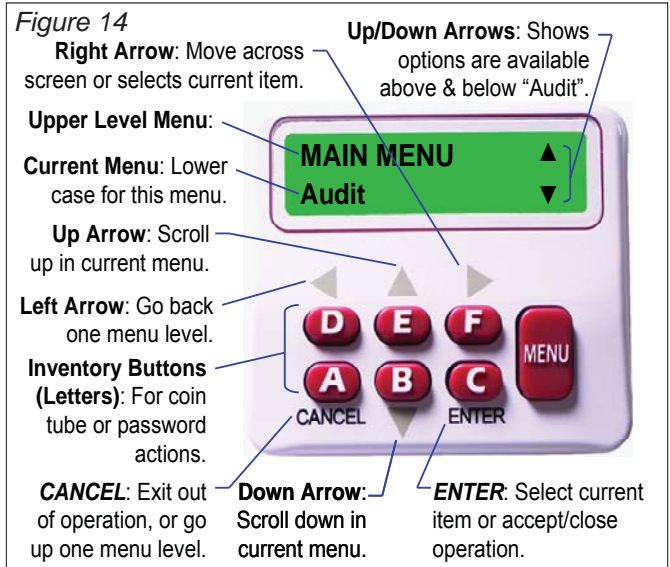

Setting Par / Float (optional)

Float Mode, also known as parring, records and maintains a predefined level of coins in the tubes, and typically will maintain a lower level of change in the changer than if Float mode is not used. When using Float mode, an accepted coin will only be routed to the tube if one has been paid out.

13. You can quickly **Enable Par** at the current coin levels by simultaneously pressing the keypad hotkeys **E+F**. Then press **ENTER** to accept the displayed Par Value.
14. To disable or reset Float level, simultaneously press keypad hotkeys **D+F** to **Disable Par**.

? When I add coins prior to resetting my float level, the changer automatically kicks coins out. Why?

Overfill Paydown automatically returns any coins that exceed the Float Mode level. Any coins added to the coin tubes after parring, or adding coins prior to setting a higher Float level will result in these extra coins being sent to the coin return. See Step 15 above for how to Disable Float.

? Why is it that sometimes when setting a Float Level, the Par setting does not match the exact value of coins loaded in the changer?

This could be for a couple of different reasons. The coin level sensing is accurate to within ± 2 coins, so there could be a discrepancy based on coin stack thickness tolerances.

Secondly, when setting the float level, the coin level sensing assumes a minimum of the hidden coin level (5 coins per tube) for all enabled tubes, even if there are no coins loaded. To eliminate this condition, disable all unused tubes by entering **MENU/SETUP/CASSETTE/CUSTOM** and set unused tubes to “- -”.

Figure 15

Setting / Disabling Par

1. Push **D+F** to Disable Par.
2. Open cassette and load desired level of coins.
3. Close cassette and wait for steady state operation (cycling display).
4. Press **E+F** to **Enable Par**, and accept by pressing **ENTER**

Or

1. Press **MENU** and scroll using arrow keys to the screen below.

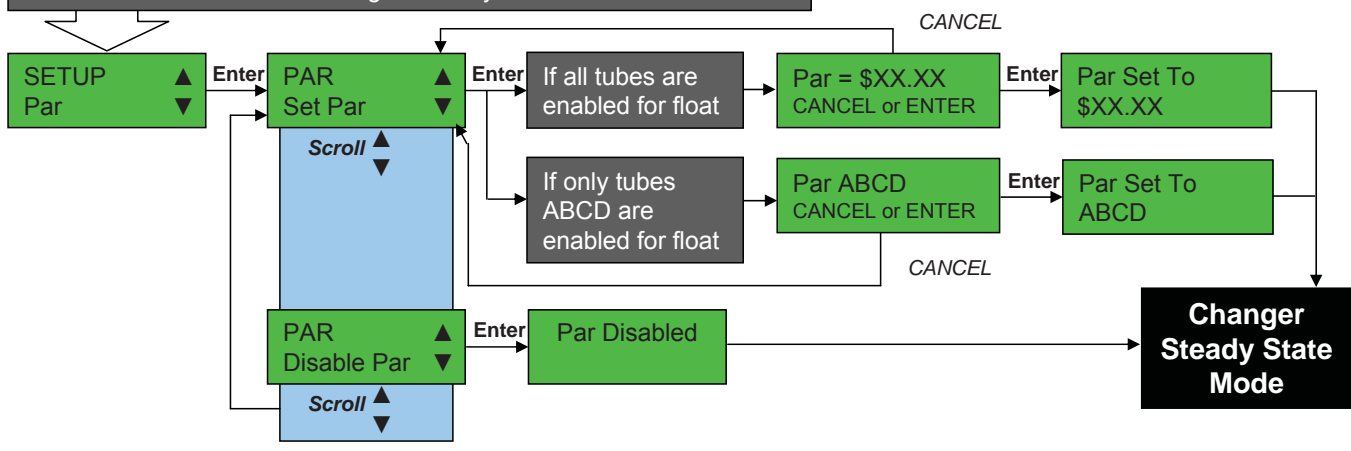

SECTION 3: GENERAL CHANGER OPERATION

Steady State User Display

During steady state operation, the user display will show one of four typical screens as shown in Figure 16.

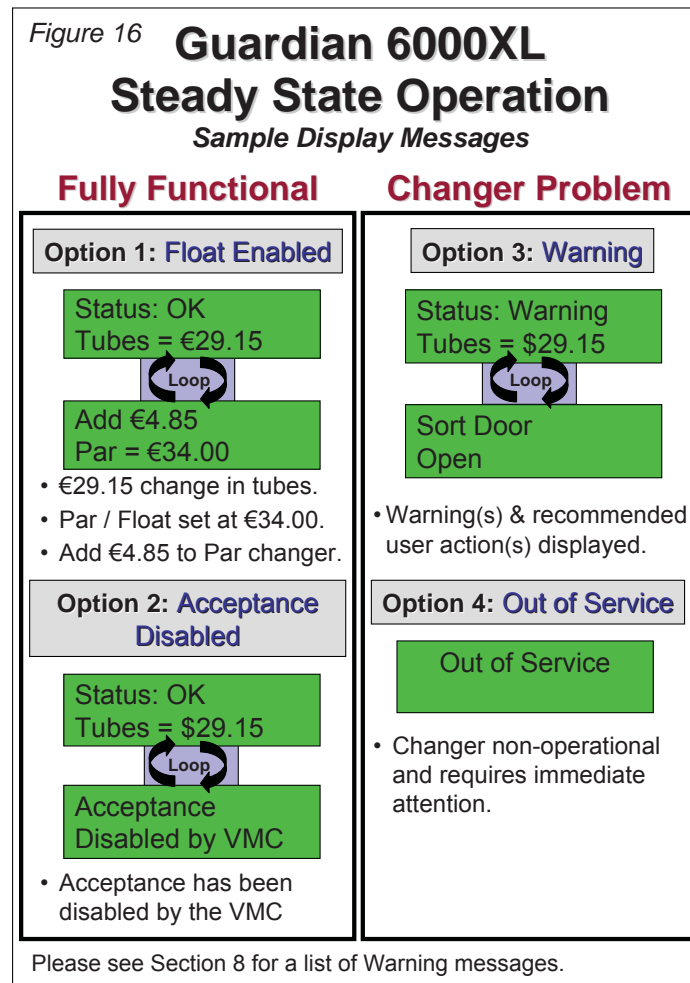

General Changer Operation

Acceptor Module

The Acceptor Module contains the majority of the Guardian's control logic. The Acceptor can electronically validate up to 32 different coin types and actively route accepted coins to six coin tubes or to the vending machine cashbox. A LCD display provides visual feedback on the functioning condition of the changer. Six inventory buttons allow the user to manually dispense coins from the coin tubes. The *MENU* button allows access to enter special programming and features.

The Acceptor Module transmits credit and status information and receives payout and control information from the vending machine. The Acceptor monitors each coin tube to know when it is full so any additional coins can be routed to the cashbox.

Coin Acceptance

Deposited coins enter the coin inlet funnel, where they are directed down a coin rail formed by the mainplate and acceptor gate. Optical and magnetic sensors positioned along the rail validate the coins. When the coin reaches the end of the coin rail, motor and solenoid-operated coin doors direct the coins to either the coin tubes, cashbox or to the coin return chute.

Pressing the escrow lever physically opens the acceptor gate, allowing bent coins and foreign materials to fall into the coin reject chute. Movement of the front gate is also detected by the coin changer electronics and is communicated to the vending machine controller causing any customer credit to be paid back.

If coins are deposited too closely together (fast feed), one or more coins may be rejected if the

SECTION 3: GENERAL CHANGER OPERATION

acceptor cannot safely route them to the appropriate coin tube. When any object (coin, counterfeit coin, etc.) is rejected, the changer will temporarily delay coin validation to allow the rejected object to exit the changer.

Housing Module

The Housing Module consists of the changer housing, protocol harnesses and for Executive (Protocol A) models the Executive board. The backside of the housing has three mounting holes for attaching the Guardian changer to the vending machine. The cashbox coin chute is also part of the housing.

Coin Tube Cassette

The coin cassette contains the six coin tubes that store coins for change payout. The front and back halves of the cassette hinge together to form the coin return chute. Rejected coins from the acceptor pass through the center of the cassette assembly and fall out the bottom of the coin changer. Accepted coins, depending on routing, are guided into either the coin tubes or the cashbox.

Payout Module

The bottom of the Guardian changer is the Payout Module. Coins stored in the coin tubes of the cassette are dispensed by the payout modules motor driven belt. The belt has two pins attached to it, which engage a sweeper at the bottom of each coin tube. When the sweeper is engaged, one coin is released from the coin tube. The acceptor module sends information to the payout module for dispensing coins from the cassette.

Coin Level Sensing

The Pulse-Echo coin level sensing method emits and detects sound waves. The number of coins is calculated by the amount of time it takes the emitted sound wave to deflect off the coin stack and return to be detected. (See Figure 17)

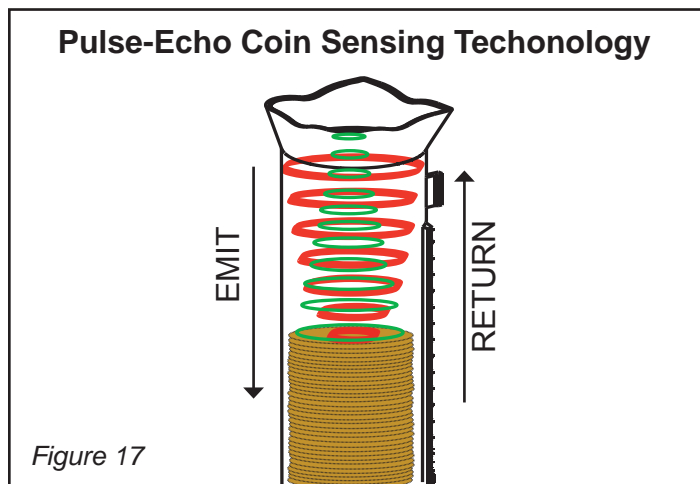

? How often does the changer scan the tubes?

The Guardian will automatically scan after any coin deposit or payout. It will also scan after any "change in state", e.g. when the payout cassette or sorting door is opened then closed.

? I added one coin to a tube and the coin level sensing did not detect it. Why?

The Pulse-Echo coin level sensing method is accurate to within ± 2 coins. It may not necessarily detect a difference when a single coin is added. This is normal and is within the technology's margin of error.

? Does the Guardian require tube sensing calibration as with some other models?

No, it does not require any calibration to attain its level of accuracy.











Menu Navigation

The following views summarize menu navigation for the Guardian 6000XL™ changer:

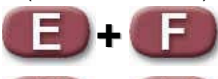
- General menu navigation and keypad functionality is shown in Figure 14.
- The special “hotkeys” to streamline key operations are shown in Figure 18.

Figure 18

Guardian 6000XL Hotkeys

 (any individual alpha key)	Displays coin denomination and quantity for the selected tube (A-F) with number of coins to add/remove when float is enabled. Also used for manual coin payout.
 (1 press)	Accesses Main Menu .
 (2 presses)	Begins Audit Current data reporting.
 (Hold for 5 seconds)	Activate / Deactivate keyboard lock
	Sets Par at current coin levels.
	Disables Par mode.
	Shows payout cassette configuration.
	Initiates Par Paydown (if enabled).
	Initiates Manual Fill mode (alternate MENU + E).
	Initiates Tube coin count scanning
	Select Language

Menu Structure

The main menu consists of three primary functions: 1) Audit capabilities 2) Changer Setup, and 3) Recommendations. The overall menu layout is shown in Figure 19. This figure is also your guide showing where each menu topic is reviewed in this user manual. Figure 20 shows more information specifically on the Setup menu.

❓ What happens if I do not complete a programming change and walk away mid-stream?

For safety purposes, the Guardian times out if a programming step is not completed. After about 45 seconds it will default to the prior settings.

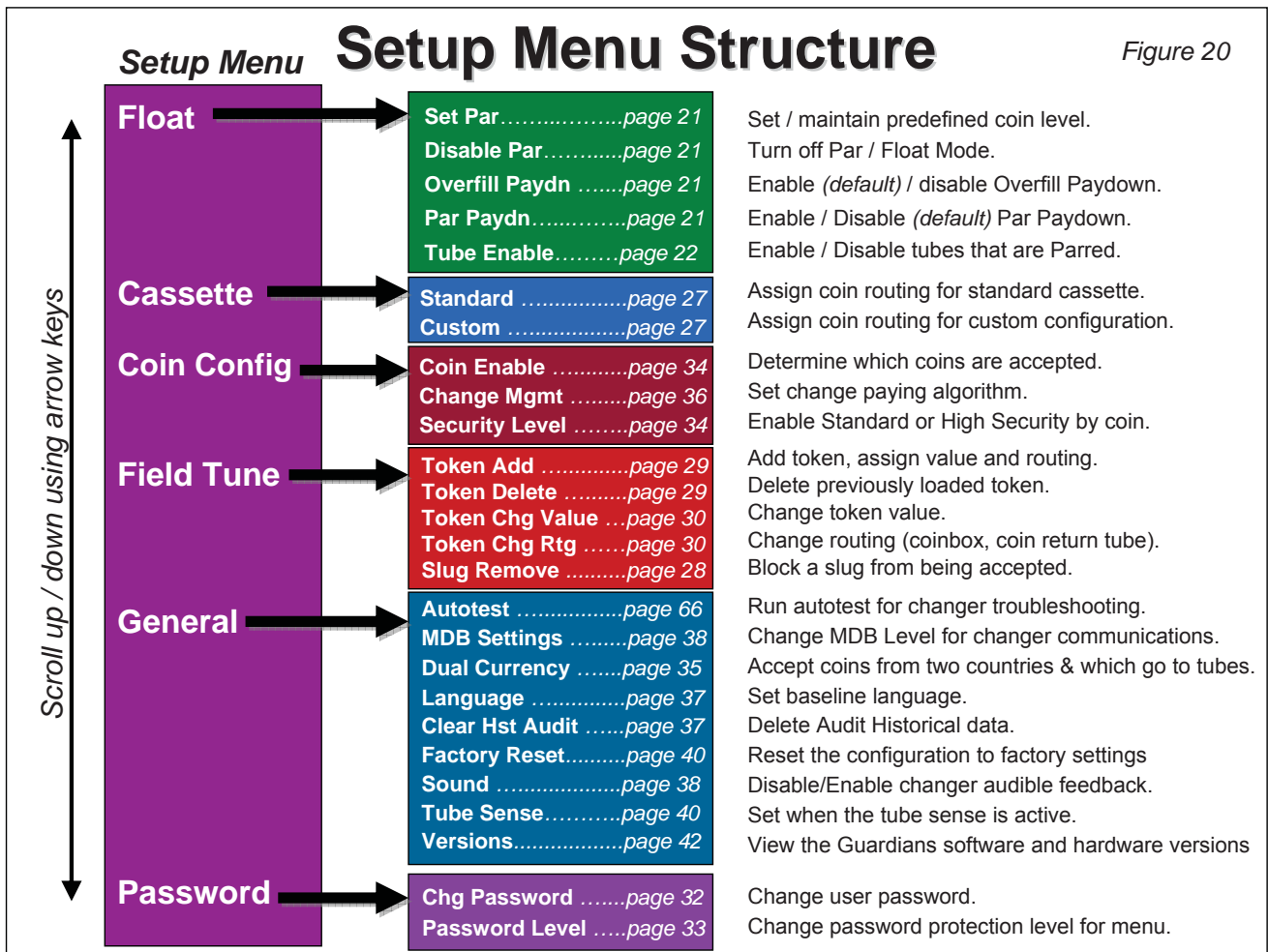
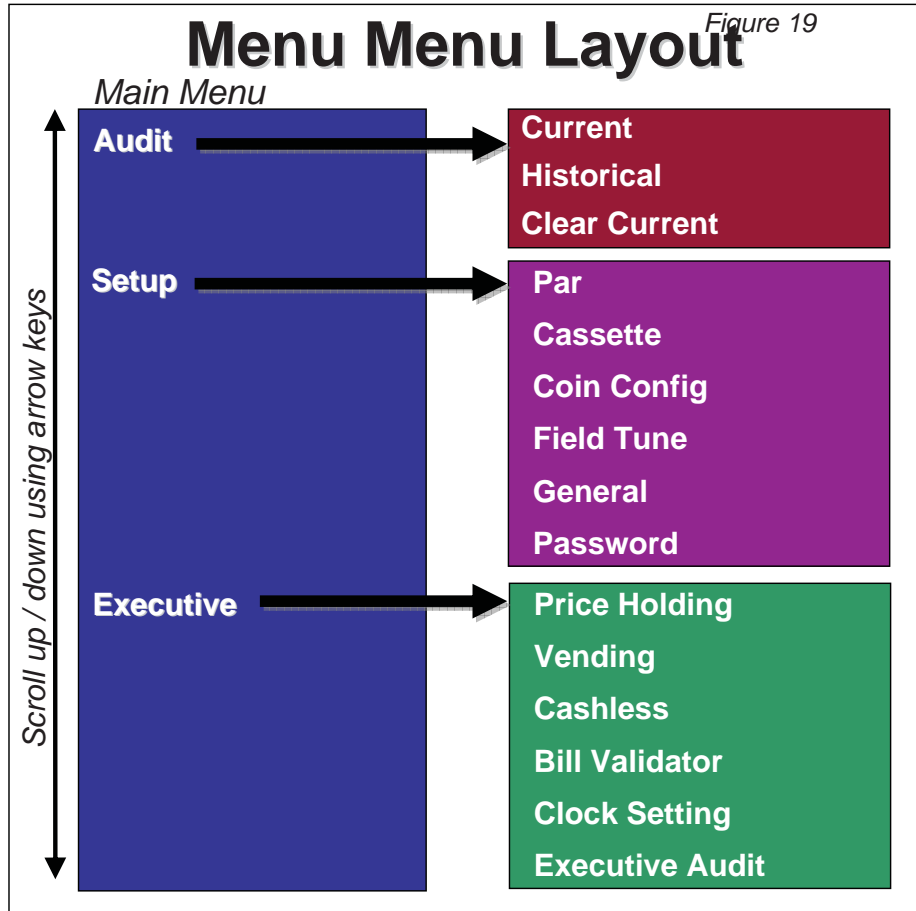

SECTION 4: TYPICAL USAGE

Now that you've installed and completed the basic setup of your Guardian 6000XL™ changer, this section will review typical route operations. More detailed setup capabilities are detailed in Section 5.

Parring the Guardian

Parring is the action of bringing the changer back to its original float level. This can be accomplished either via the Guardian's automated parring system (when Float has been set by the user), or visually when Float has not been set.

1. **Automated Parring System:** The simplest way to par is by using the Guardian's automated parring recommendations. See Figure 21 for details.



If coins only need to be added to the front tubes, the Sorting Door can be opened instead of the payout cassette. Otherwise, everything else is the same in Figure 21.

2. **Manual or Visual Parring:** The Guardian can also be parred visually by refilling the tubes to the approximate levels. This can be accomplished either by using the tube markings, or by using the optional Guardian adjustable par rings. The Manual or Visual Parring methods are only to be used when Float Mode is disabled.
 - Open the payout cassette (all tubes) or sort door (front tubes only) and load coins to the desired tube level marking.

Automated Parring Routine

Figure 21

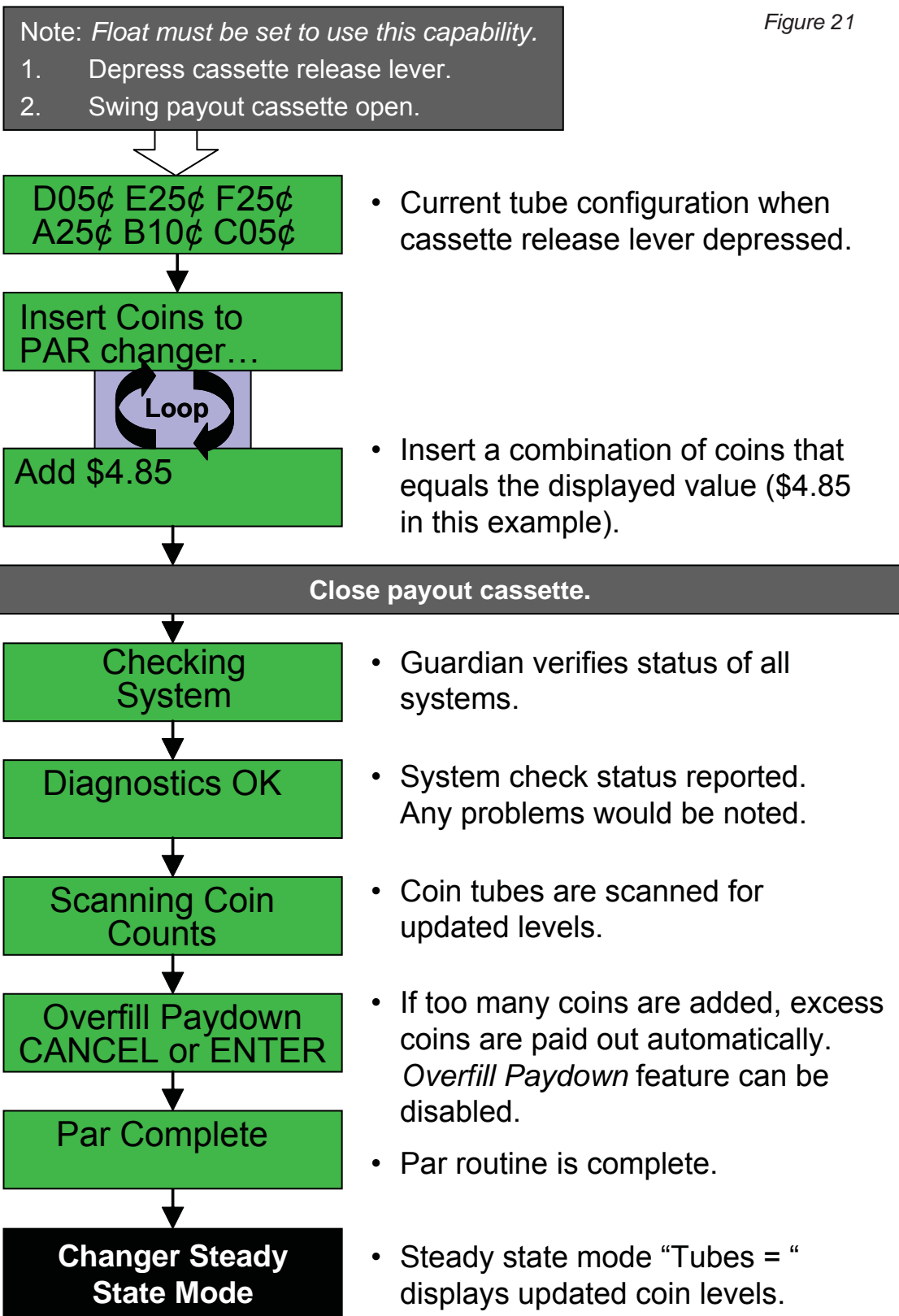

Setting Par / Float (optional)

See Section 2: Installation & Setup.

Enabling / Disabling Overflow Paydown

When the changer is in Float Mode, the Overflow Paydown feature causes the changer to pay out any coins in excess of the Float level that are inserted during parring. Overflow Paydown is defaulted to "on" in the standard changer setup.

See Figure 22 for how to turn this feature on or off.

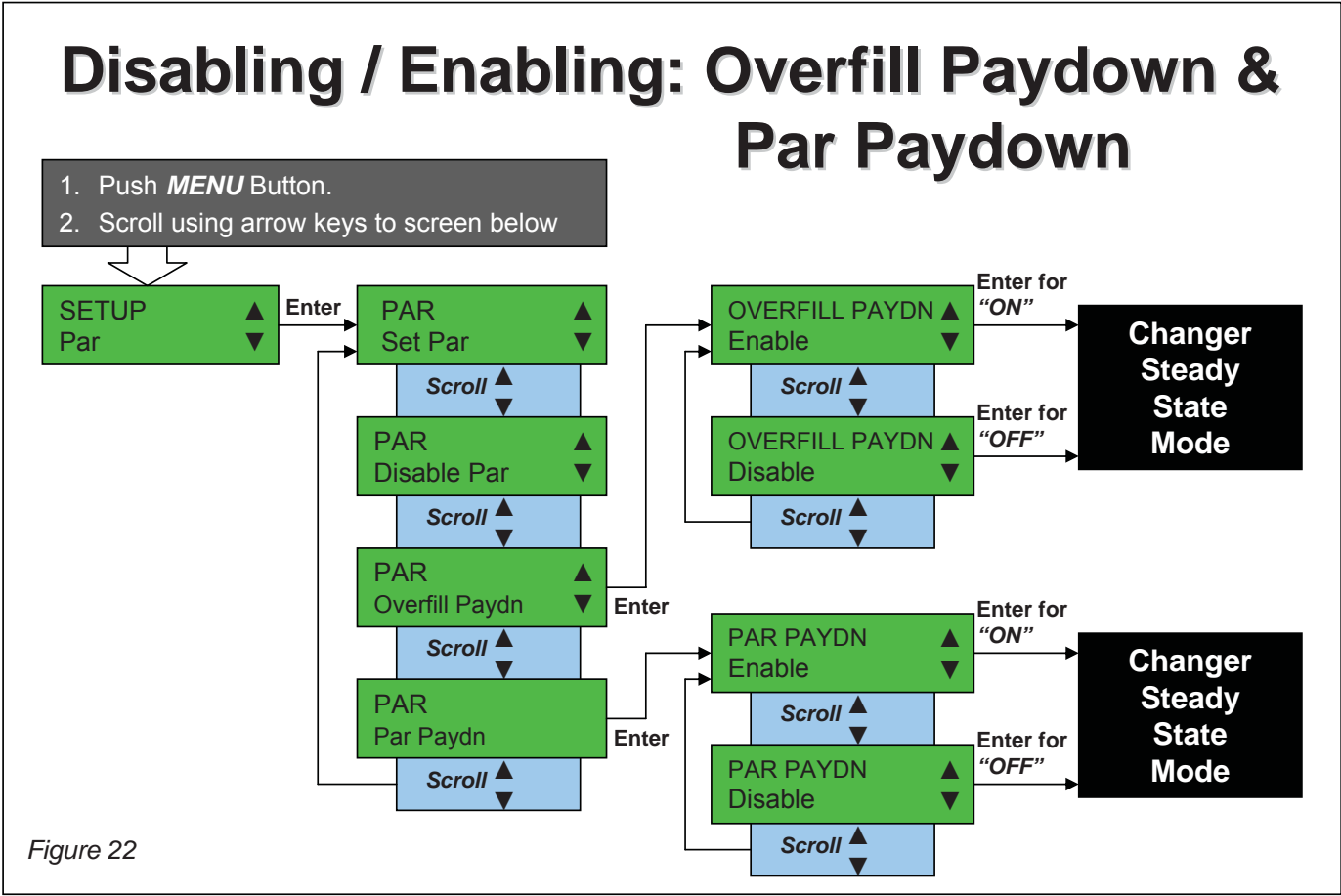

Figure 22

Par Paydown

When the changer is in Float Mode, the Par Paydown feature causes the changer to route all accepted coins to the tubes until they are full; the balance then go to the cashbox. Par Paydown is commonly used to ensure the maximum change making capability is always available without having to manually fill the changer during the route visit. Par Paydown is defaulted to "off" in the standard changer setup.

See Figure 22 for how to turn this feature on or off.

✓ Tube Enable

Before putting the changer in Float Mode it is possible to set which tubes will have the float enabled. All enabled tubes will be set to the current coin level when float is enabled. All disabled tubes will fill as normal.

By default all of the tubes are enabled.

See Figure 23 for how to enable/disable tubes.

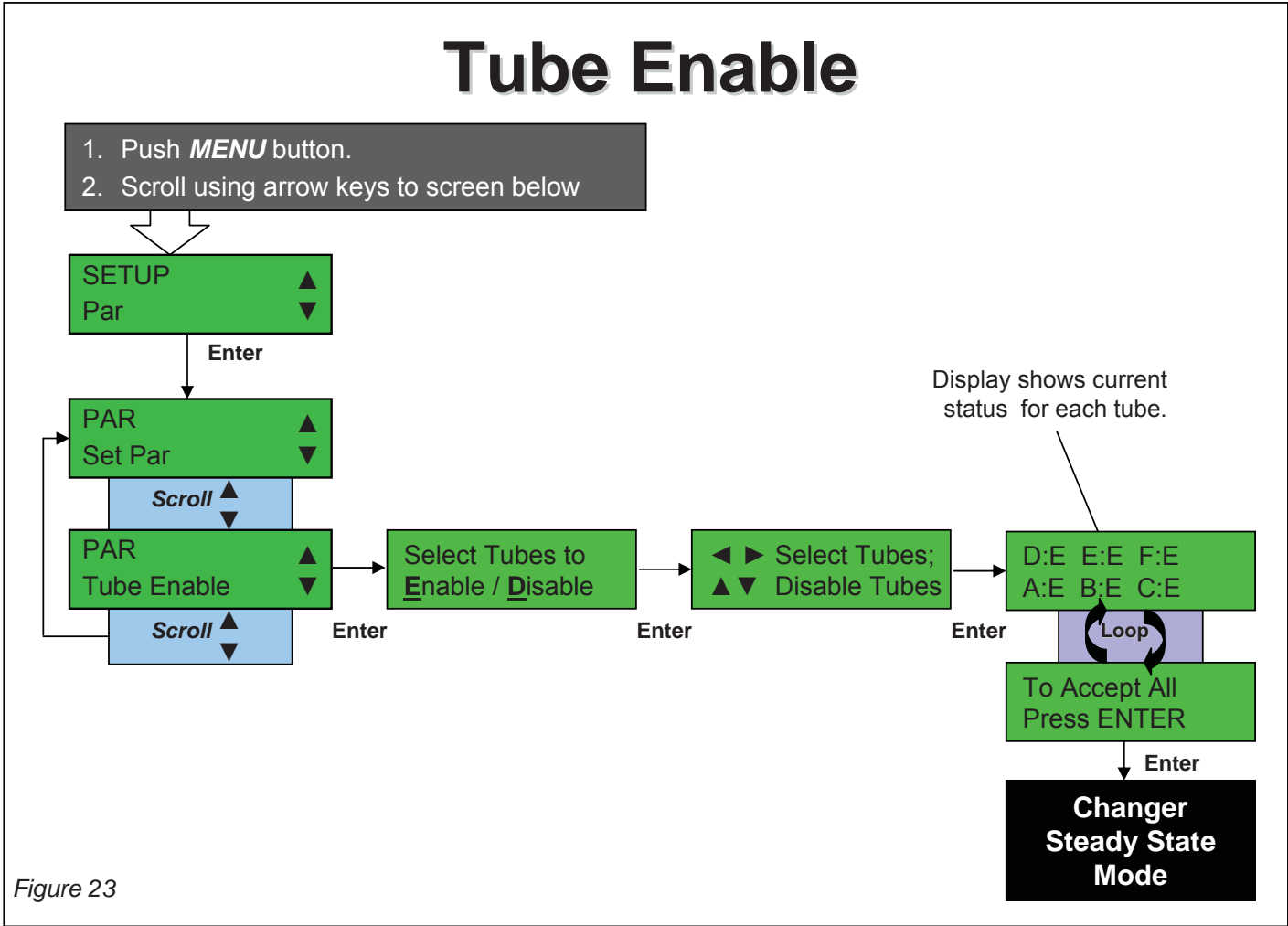

Audit Reporting

The Guardian features a means of tracking and reporting all sales. Audit data consists of two types of data: 1) Current Data, and 2) Historical Data.

- Current (Resettable) Data:** consists of changer data stored since the last user reset. See Figure 24 for details.



The user can quickly begin Audit Current Data reporting by pushing *MENU* twice. Refer to Figure 18 for additional information on changer hotkeys.

- Clear Current (Resettable) Data:** Clears all changer data since the last user reset. Current data can be cleared at any time. See Figure 24.

How are 'Exact Change Losses' calculated?

Historical sales activity is used to calculate lost sales when in the exact change mode.

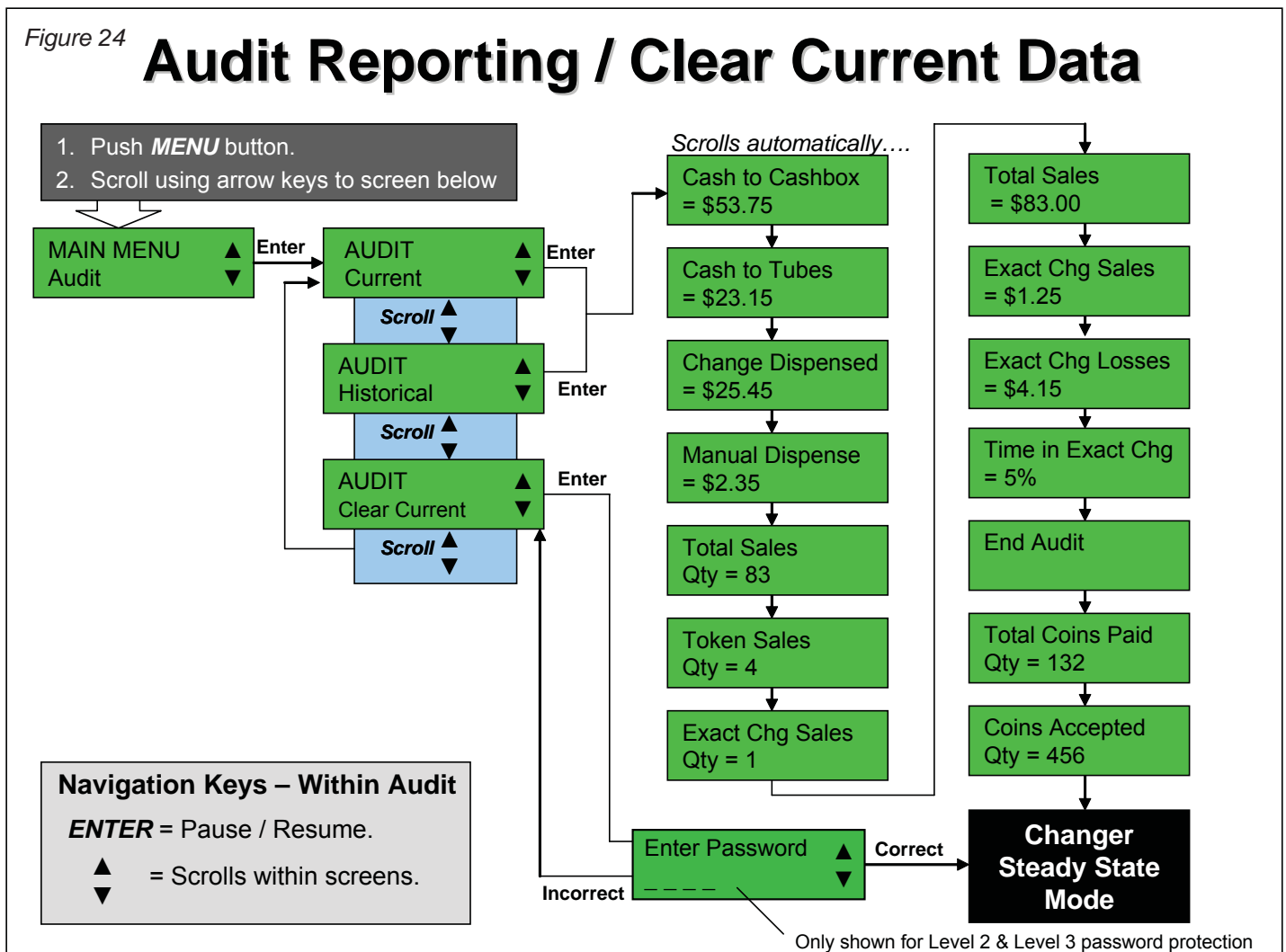

❓ How are 'Total Sales' quantities and values calculated?

Unfortunately, there is no "MDB vend" command, so this is an estimate. For our audit fields, a vend is defined as **all coins being disabled by the VMC, then re-enabled**. Some vending machine controllers do not disable coins before a vend, so we may register an incorrect number of vends. Also, some vending machines disable coins while in service mode. So, the coin changer would register a vend every time the operator enters and exits service mode. The value of vends is also an estimate, and does not include bills.

3. **Historical Data:** consists of data stored since the changer was first put in service. Audit Historical Data displays the same categories of data as Current Data, the totals will just be from the beginning of the changers service life. See Figure 24 for details.



Historical Data can also be reset for extreme cases where the user does not want their sales data to be revealed; e.g. changer is being sold, etc. See Figure 44 for more information.



Changing the Payout Coin Tube Configuration

Your Guardian will typically incorporate a Standard Cassette configuration. The Guardian features the capability of changing individual tubes within the payout cassette.

The Guardian coin tube locations are designated as shown in Figure 25.

Please contact your Coinco Sales Rep about customization of standard cassettes or see either www.coinco.com or www.coinco-europe.com

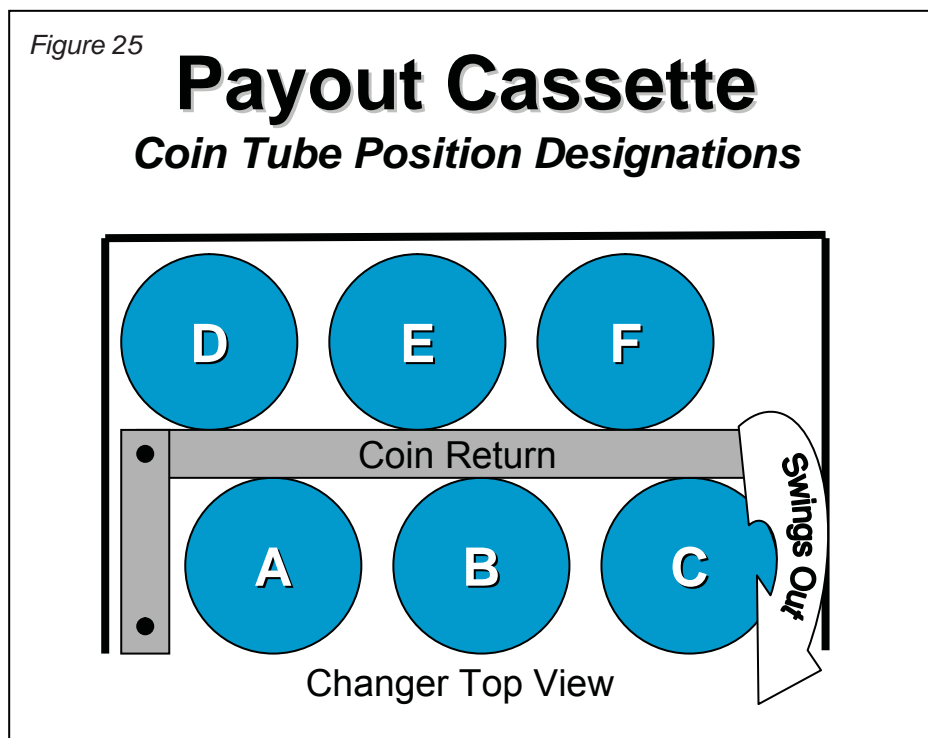

Changing the Coin Tubes

Tubes for very small and very large coins have restrictions on their placement.

Each coin tube will require a specific coin shim in order to accurately pay out that coin thickness.

1. Rotate the Payout Cassette Release Latch downward to open the coin payout cassette. Refer to Figure 26.
2. Pivot the payout cassette out of the changer housing by pulling on its lower right corner (See Figure 27). Once the latch has been depressed, the payout cassette must be at least partially opened before it can be closed and reseated properly.
3. Lift the cassette straight up to remove it from the coin changer (See Figure 28).
4. To remove an individual coin tube, hold the cassette assembly then gently pull the top of the coin tube forward to unsnap the top of the tube. See Figure 29.
5. Tilt the top of the tube away from the cassette and lift the tube out. See Figure 30.
6. Install the replacement coin tubes and shim assembly by first inserting the bottom of the tube in the cassette, then pivot the top of the tube and snap it into the upper part of the cassette. Check that all coin tubes are secured to the cassette.
7. Reinstall the payout cassette into the housing.

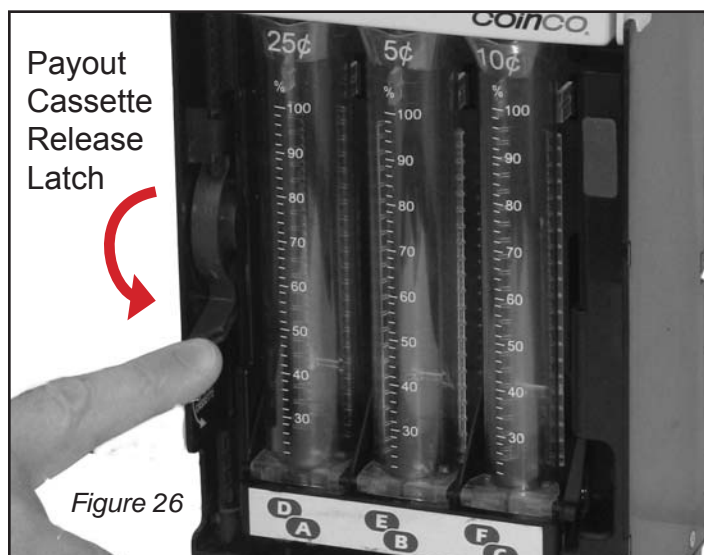

Figure 26

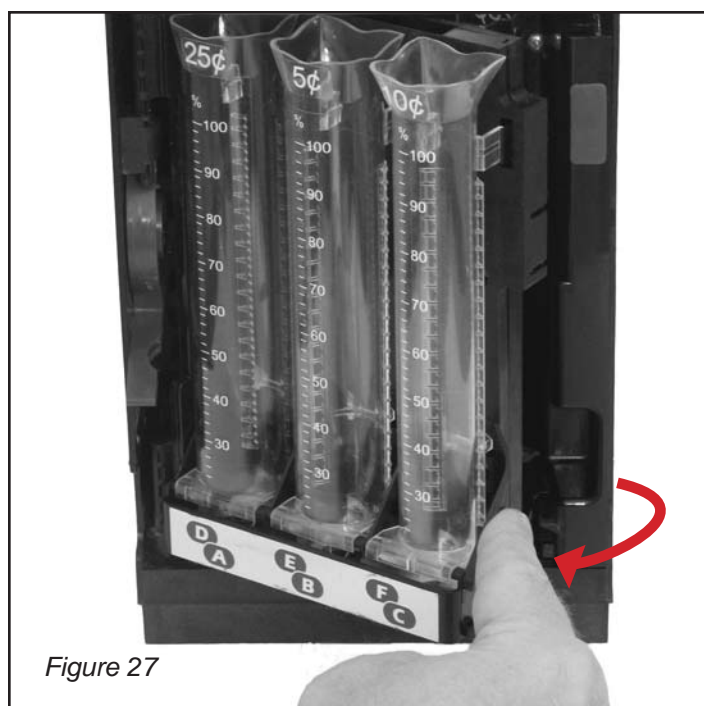
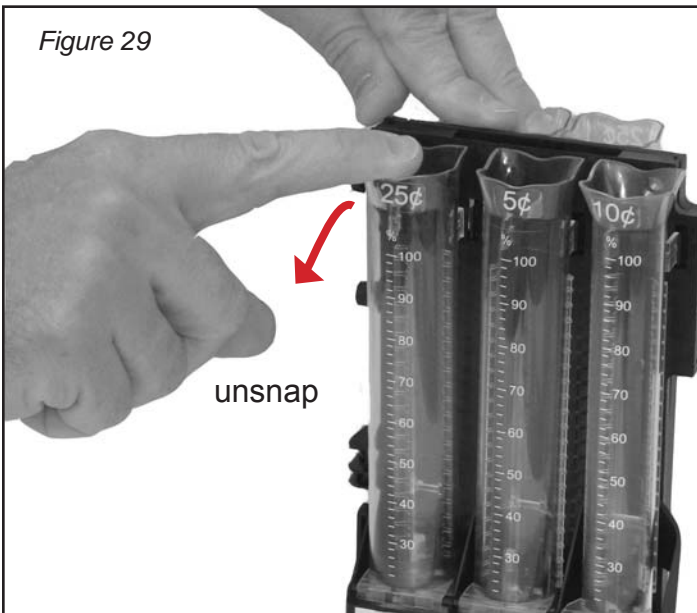
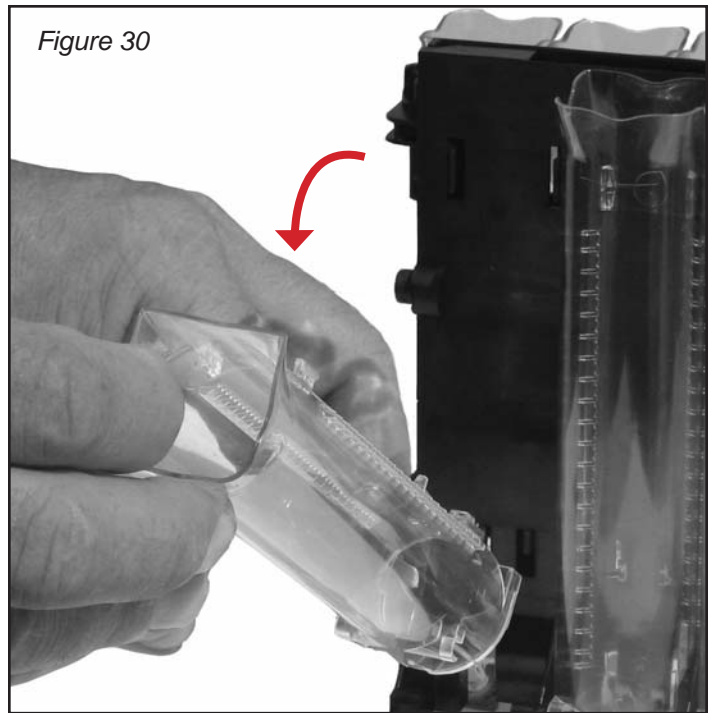
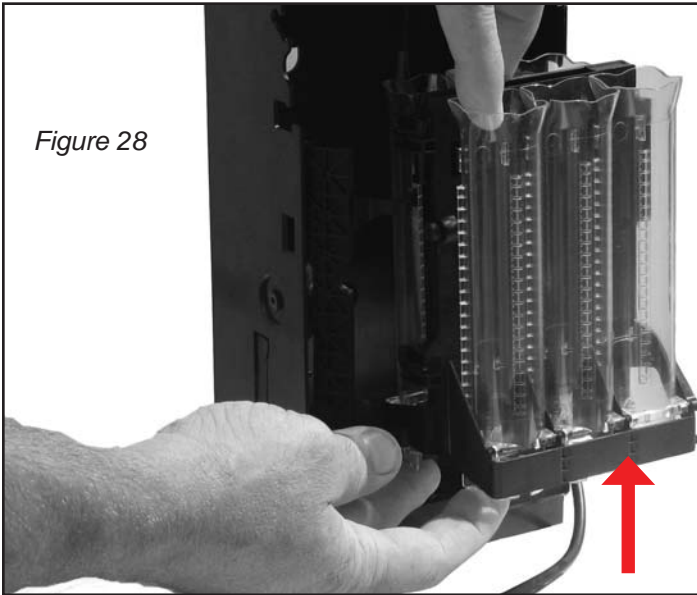

Figure 27

Programming the Coin Routing

Whenever the coin tubes are changed, the Guardian must be reprogrammed to route coins to the new tube locations. See Cassette Configuration - Using a Custom Configuration.





Cassette Configuration

Cassette configuration assigns which coins route to which payout tubes.

Your new Guardian changer will already be configured for the factory cassette and coin routing. This step of changing the cassette configuration is only necessary if:

- a payout cassette has been replaced with a cassette containing different coin tubes, or coin tubes in different positions.
- individual coin tubes have been replaced (or moved).

There are two ways to assign coins: 1) *Using a Standard Cassette*, or 2) *Using a Custom Configuration*.

1. **Using a Standard Cassette:** If you are using a Standard cassette, find the cassette configuration designation (such as BB, BD, etc) and proceed to Figure 33 to enter this cassette configuration. The Guardian will automatically set the coin routing based on the selected Standard cassette.

A list the standard cassette configuration designations are available from either www.coinco.com, www.coinco-europe.com or your local Coinco Sales Representative.

2. **Using a Custom Configuration:** a custom configuration is any combination of tubes and/or coin routing other than the standard cassette configurations. If you want to reconfigure the payout tube configuration and have not already done so, please refer to *Changing the Payout Coin Tube Configuration* before proceeding. After this has been done, you will need to reconfigure the coin routing. See Figure 31.

 If you do not plan to use all 6 coin tubes, leave tubes installed and **make sure to disable coin routing and coin level sensing for the appropriate tubes**. This is done by entering “---“ when assigning coins; see Figure 31 or an example.

 *On some Vendo and Dixie-Narco machines, certain changer setup modifications (tube reconfiguration, changing coin routing, token additions/deletions) may not be recognized. If this occurs, cycle power to the main controller board to correct the problem.*



Tokens cannot be routed using the *Custom Cassette* menu. The *Token Routing* menu should be used.

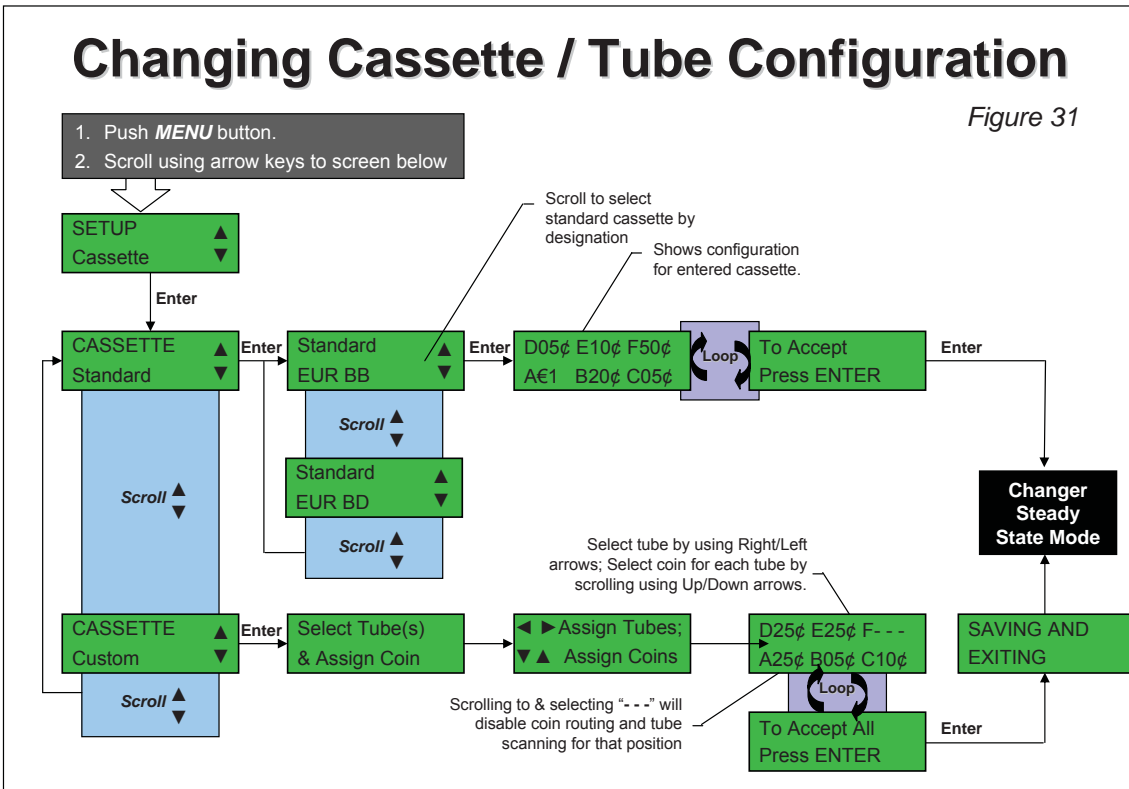

Eliminating a Slug

Slugs are counterfeits or foreign coins that are used by thieves to gain credit for a higher value domestic coin. The Guardian enables simple blocking of slugs while the changer is still on site.

Slugs can easily be blocked by completing the simple field tune in Figure 32. You will need at least one sample of the slug to be blocked to tune the changer. Eliminated slugs can be routed to the cashbox to prevent thieves from re-using them.

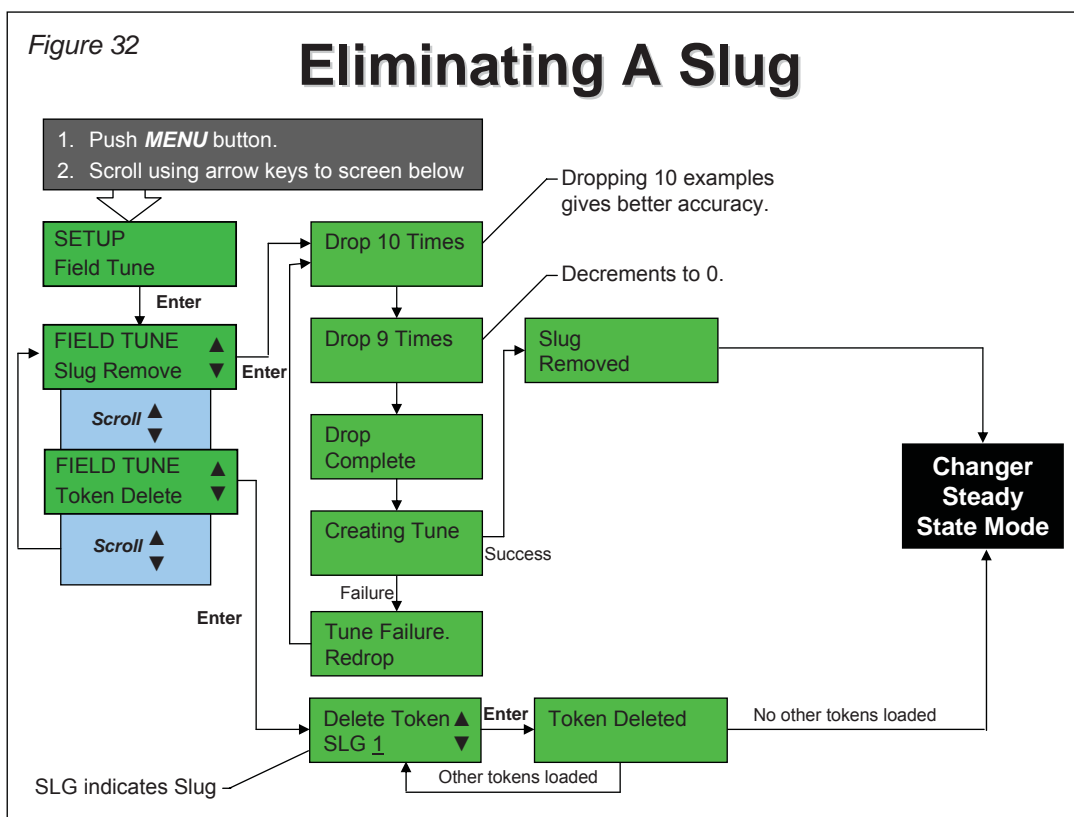

Working with Tokens

The Guardian 6000XL™ features a wide range of token capabilities all of which can be accomplished while the changer is still on location. These capabilities are covered here.



All token capabilities listed in this section can also be accomplished using the Coinco FP-5 Field Programmer.



Adding A Token

Enables acceptance of a token.

Tokens can easily be added while the changer is still on site by completing the simple field tune in Figure 33.

i On some Vendo and Dixie-Narco machines, certain changer setup modifications (tube reconfiguration, changing coin routing, token additions/deletions) may not be recognized. If this occurs, cycle power to the main controller board to correct the problem.

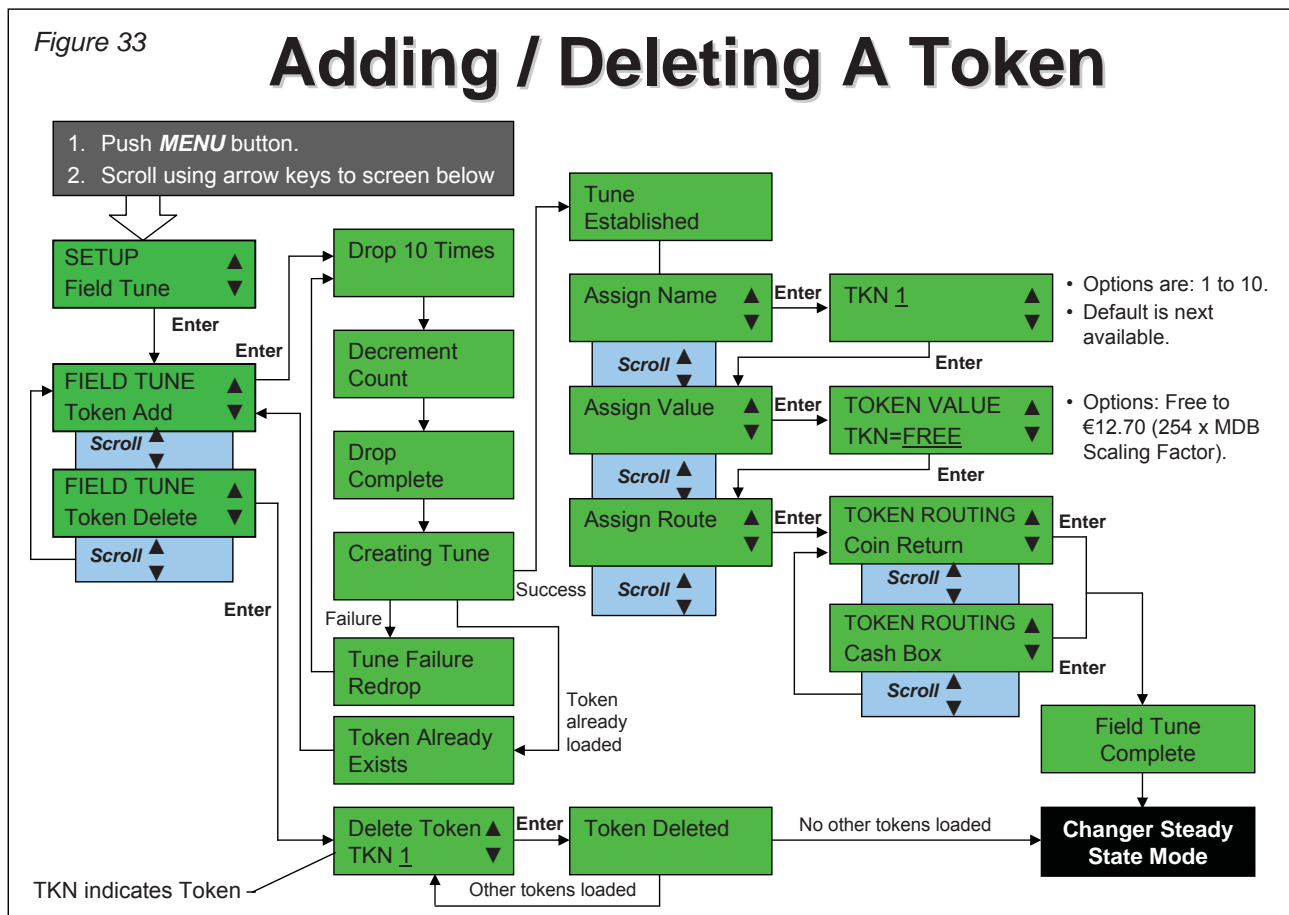

Deleting a Token

Allows the user to block acceptance of a previously tuned token.

See Figure 33 for how to delete a token.

i On some Vendo and Dixie-Narco machines, certain changer setup modifications (tube reconfiguration, changing coin routing, token additions/deletions) may not be recognized. If this occurs, cycle power to the main controller board to correct the problem.



Token Change Value

Change the value of a previously tuned token.

See Figure 34 for how to change token value.

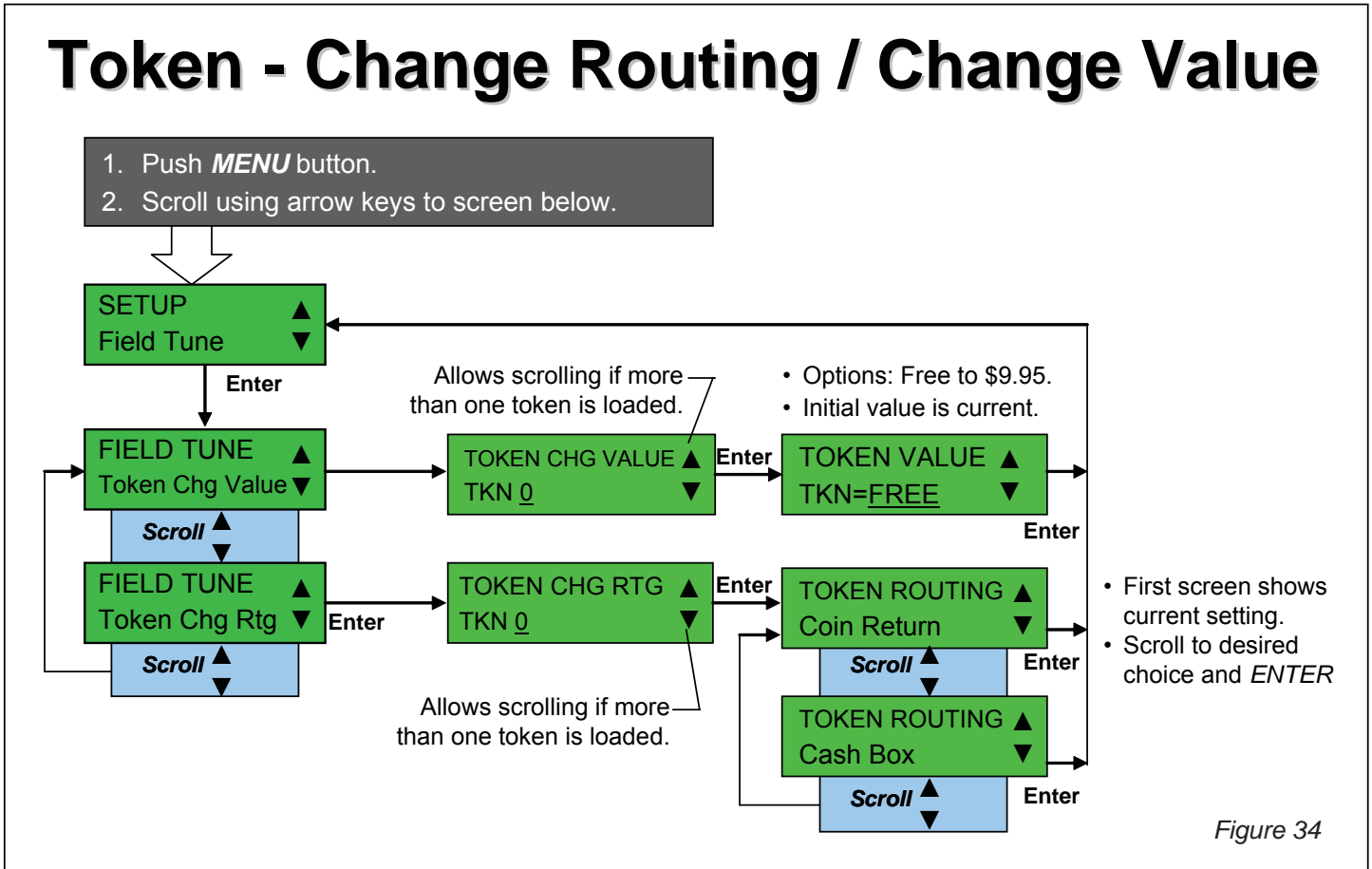

Token Change Routing

Change the routing of a previously tuned token.

See Figure 34 for how to change the routing for a token. Tokens can only be routed to either the coin return or the cashbox.



The Guardian also supports factory added tokens. The main difference between these tokens and tokens added using the method above is that they cannot be deleted. Instead they can be enabled/disabled in the same way as genuine coins.

Advanced Configuration

This section explains the lesser-used features of the Guardian 6000XL™ changer.

Password

The password section protects the more sensitive changer information.

Entering the Password

A password must be entered any time the user attempts to enter a password-protected area of the menu. These include the Password area of the Setup menu, as well as the areas defined by the Password Protection Level (see below).

The basics of Password operation are as follows:

1. The default Password for most changer configurations is D-E-F-B.
2. The CANCEL button allows you to back up while typing the password, or to back out of the Password screen entirely.
3. Once the correct password is entered, it allows access to the user's original destination.
4. There is no penalty for multiple incorrect password attempts; i.e. the screen does not lock out access to non-password protected items.

Changing the Password

Passwords can easily be changed from the default.

Valid passwords are four characters and are any combination of the letters D, E, F, and B (the four arrow keys). See Figure 35 for how to change the password.

 If the password has been changed from the standard D-E-F-B, and the user cannot remember what it is, the Password can be reset by using the Coinco FP-5 Field Programmer.

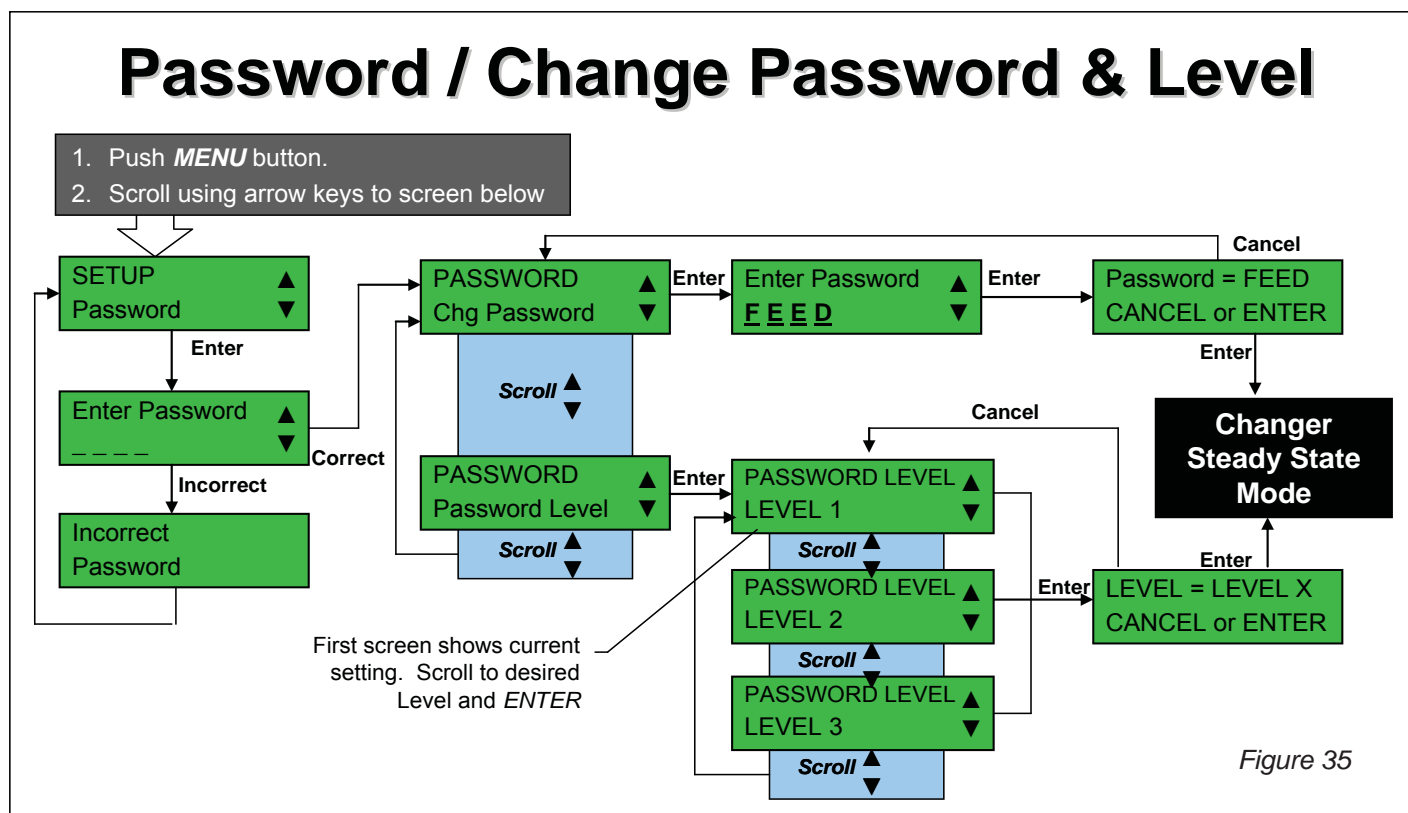

Figure 35

Password Protection Levels

Password Protection Levels allow the user to decide which information is protected by a password.

The Guardian features three levels of password protection:

- **Level 1:** The default, or lowest level of security.
- **Level 2:** Adds *Field Tuning* and the entire *Setup-General* sections of the menu.
- **Level 3:** Adds *Float*, *Cassette Configuration*, and *Coin Configuration*.

See Figure 36 for a visual representation of the Password Protection Levels. Figure 36 shows how to change the level.

Figure 36

Password Protection Levels

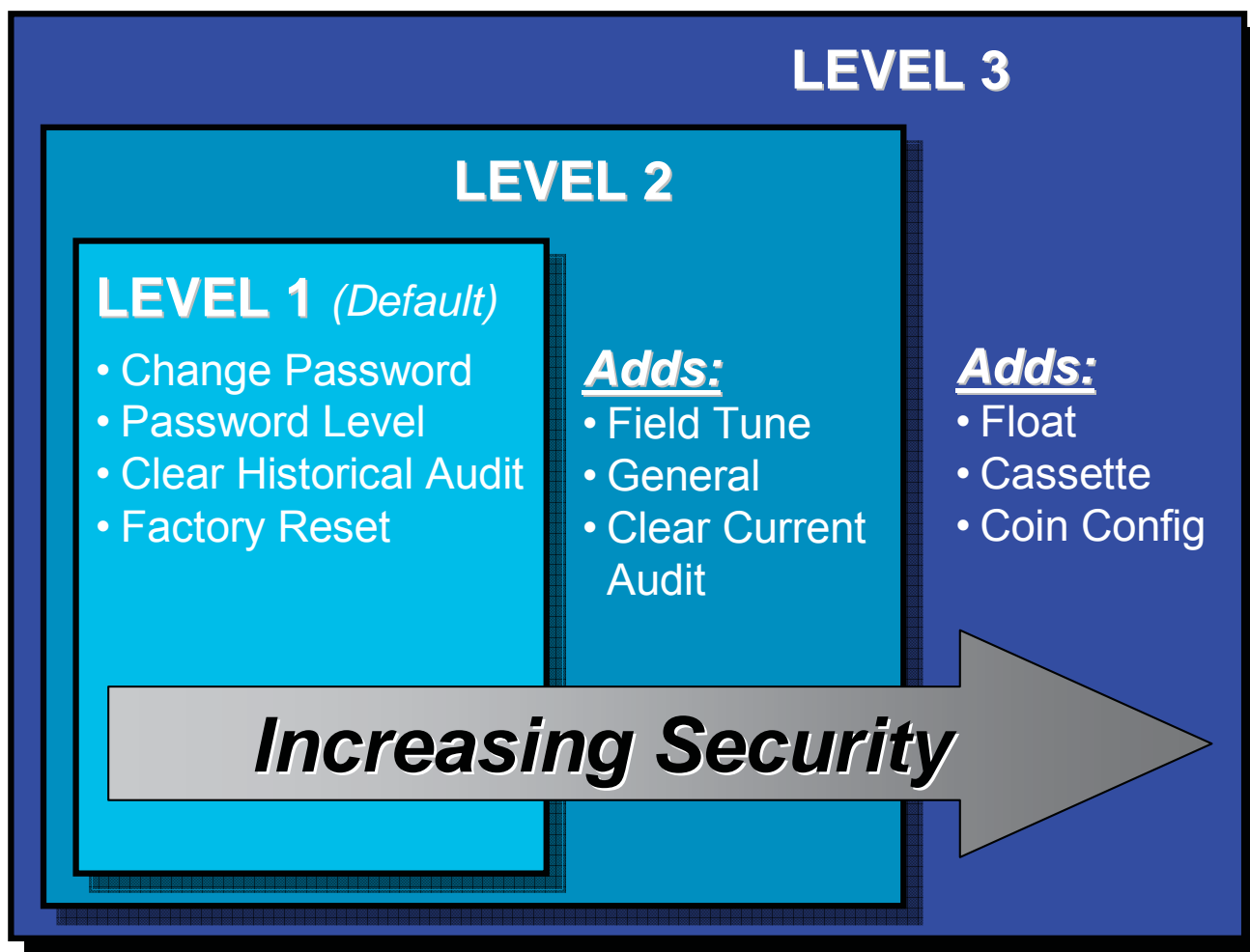

Coin Enable

Coin Enable allows the user to select which coins are and are not accepted within the standard coin set for the country.

See Figure 37 for enabling and disabling acceptance of coins within the standard coin set.

 The standard coin set for the country is determined by the changer “Country Code”. See the Guardian Naming Convention (page 6) to determine the Country Code of the changer.

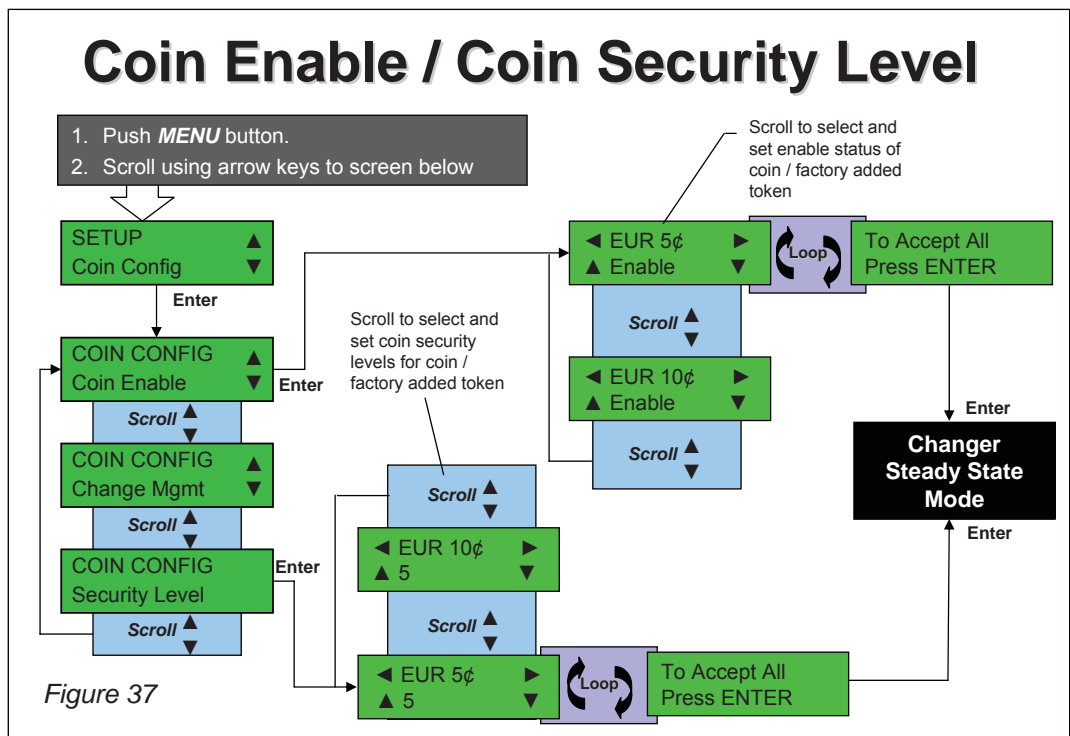

Coin Security Level

Allows the user to determine how tight the acceptance rate should be for each type of accepted coin.

The Guardian 6000XL™ features nine levels of security ranging from one to nine. Five is the default security setting.

See Figure 37 for how to change the security level for each accepted coin.

 Increasing the Coin Security Level for a coin will make it less likely that a similar slug will be accepted, yet it will also reject a higher percentage of authentic coins. It is recommended that the highest security setting only be used in specific instances to deal with higher slug rates.

Token Value

Allows the value of factory added tokens to be set

The Guardian supports factory added tokens. The main difference between these tokens and tokens added using the field tune functionality is that they cannot be deleted. Instead they can be enabled/ disabled in the same way as genuine coins. See Coin Enable.

See Figure 38 for how to set the token value.

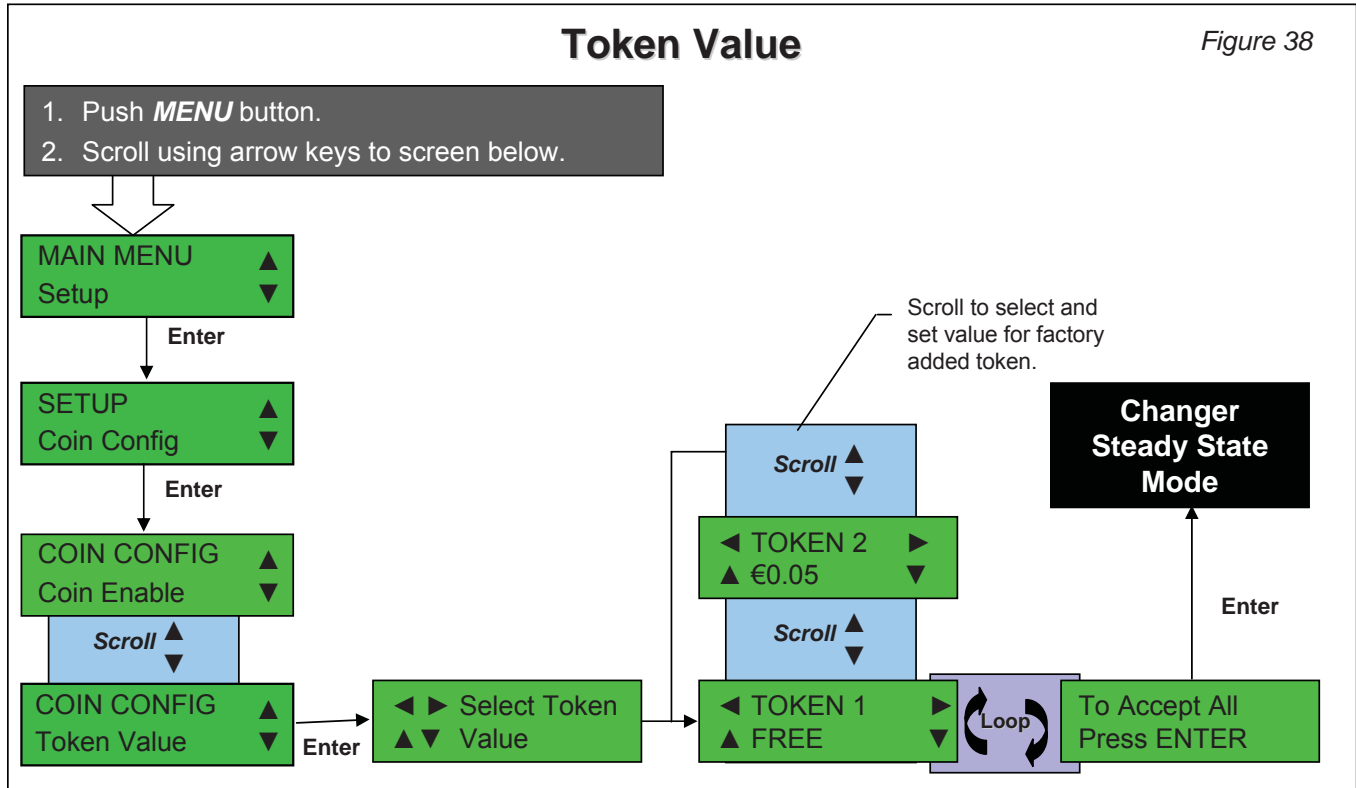

Dual Currency

Allows coins from two countries to be accepted by the changer, and allows the user to set the routing (cashbox or coin tube) for the coins.

See Figure 39 for how to enable acceptance of more than one country set of coins.

If Dual Currency is enabled, then you must select which coins are routed to the coin tubes and which are routed to the cashbox. Figure 39 shows how to set which country set is routed to the coin tubes; the other country's coins are automatically routed to the cashbox.

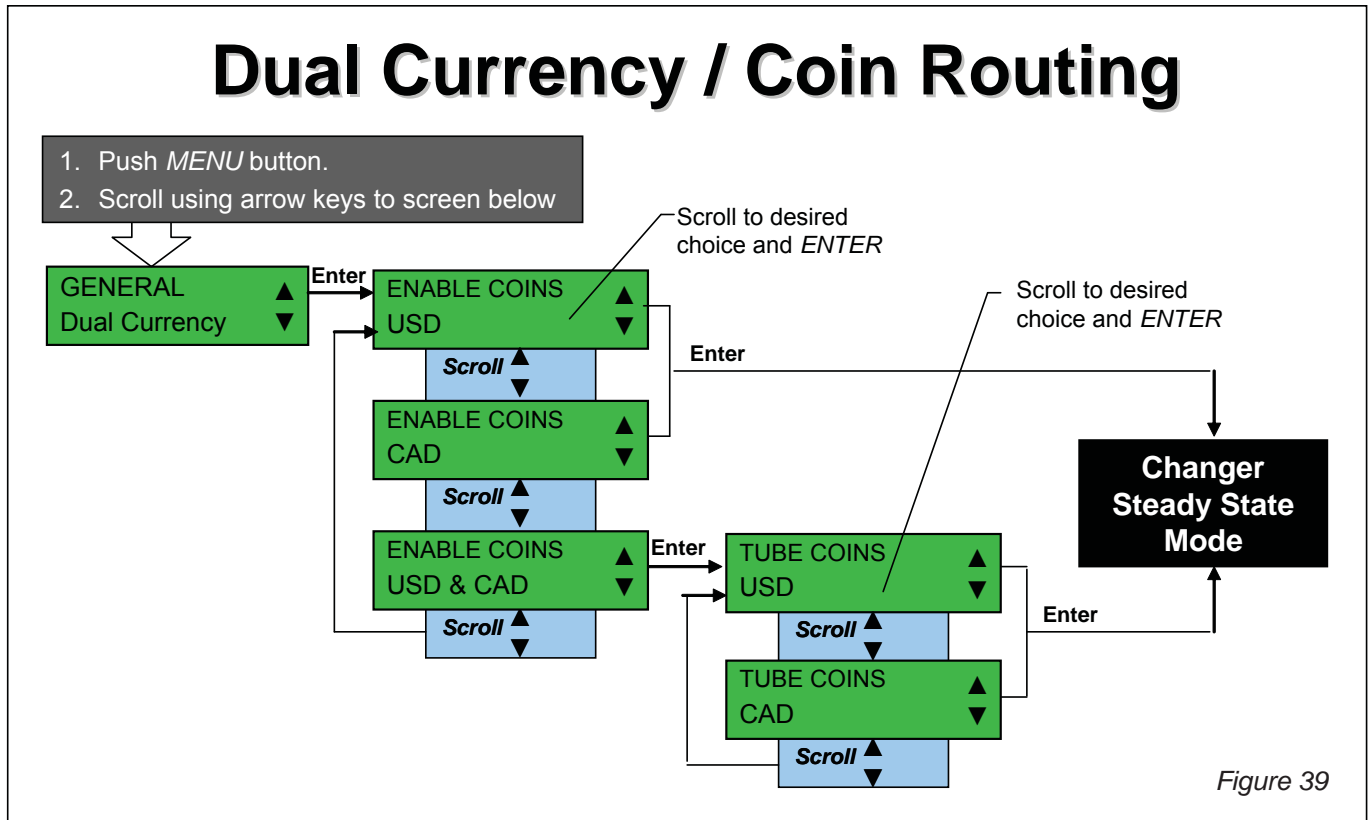



Change Management

Allows the user to select the preferred method of paying change from the tubes.

The Guardian 6000XL™ offers three alternatives for satisfying change requirements:

1. **Least Coin Payout:** Always pay out least amount of coins regardless of whether correct change can be made. Depending on the coins available for payout, there can be specific conditions where the full change due to the consumer will not be returned.
2. **Standard Alternate Payout:** Designed to *optimize the payout of change based on the existing coin tube levels* in the changer. This method will pay one of the lowest denomination tube coins from a tube determined to be full and then resorts to *Least Coin Payout*.

See Figure 40 for how to change the payout algorithm.

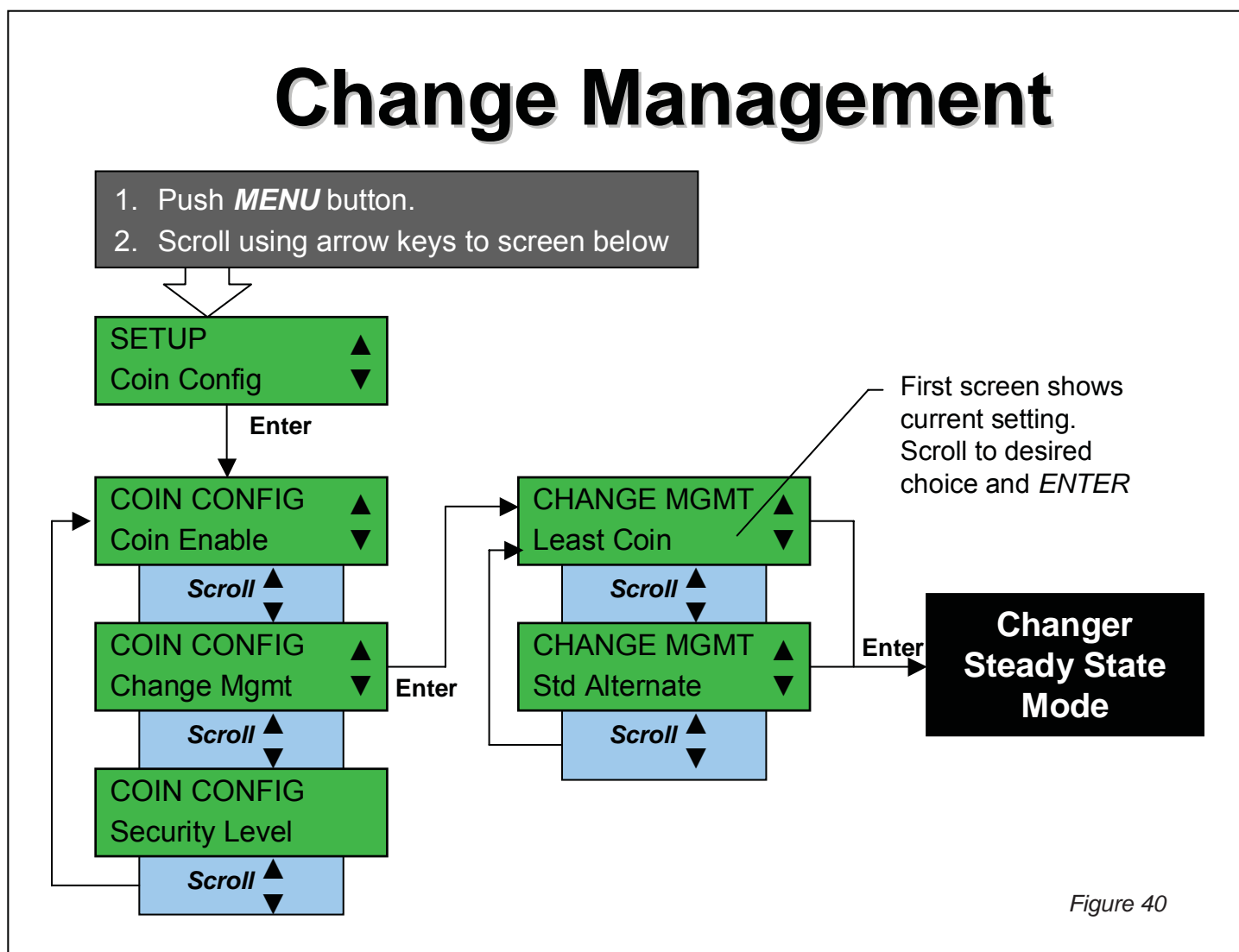



Language

Language enables the user to change the user interface LCD display language.

See Figure 41 for how to change the default language.



The standard language is defined by the changer “Country Code”. See the Guardian Naming Convention (page 6) to determine the Country Code of the changer.

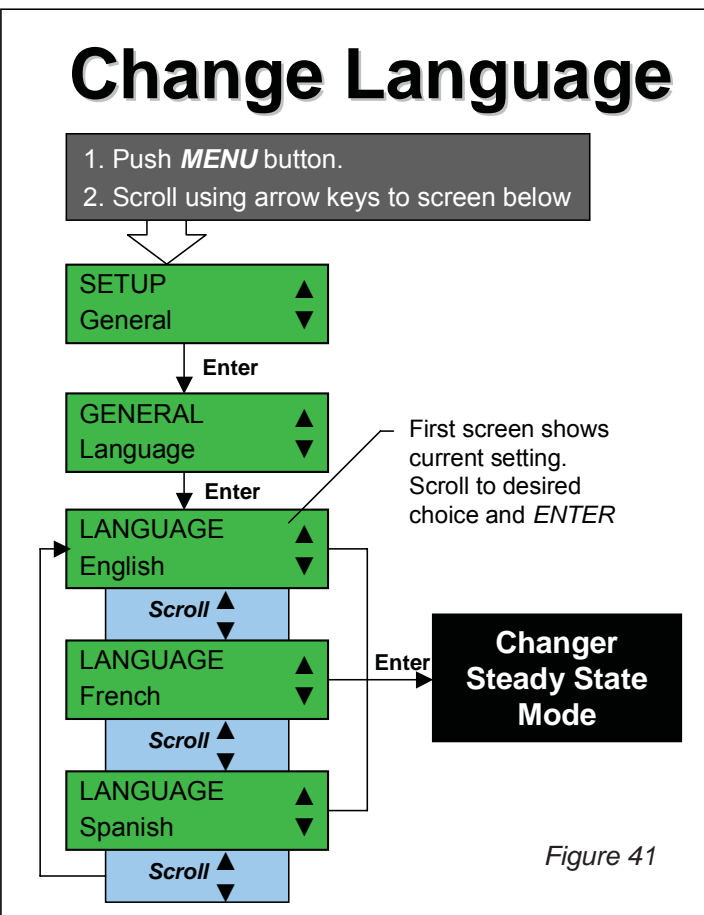

Clear Historical Audit

Clears ALL historical changer information that resides in the changer.



Historical Data should only reset for extreme cases where the user does not want their data to be revealed; e.g. the changer is being sold to a competitor, etc. Clearing the Historic Data will effect the audit data accumulated when using the changer

in Executive mode (where applicable).

See Figure 42 for more information.

Clear Historical Audit



This will delete **ALL** changer historical audit information. Data cannot be restored after this step is completed.

1. Push **MENU** Button.
2. Scroll using arrow keys to screen below

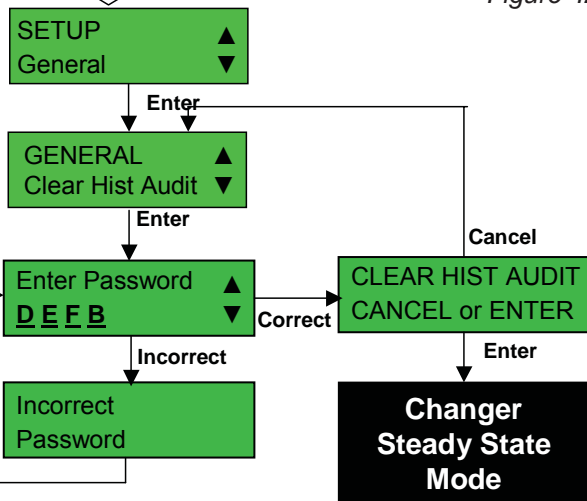



Disable / Enable Audible Feedback

Turns feedback sounds from the warning beeper “on” or “off.” The default setting is “on.”

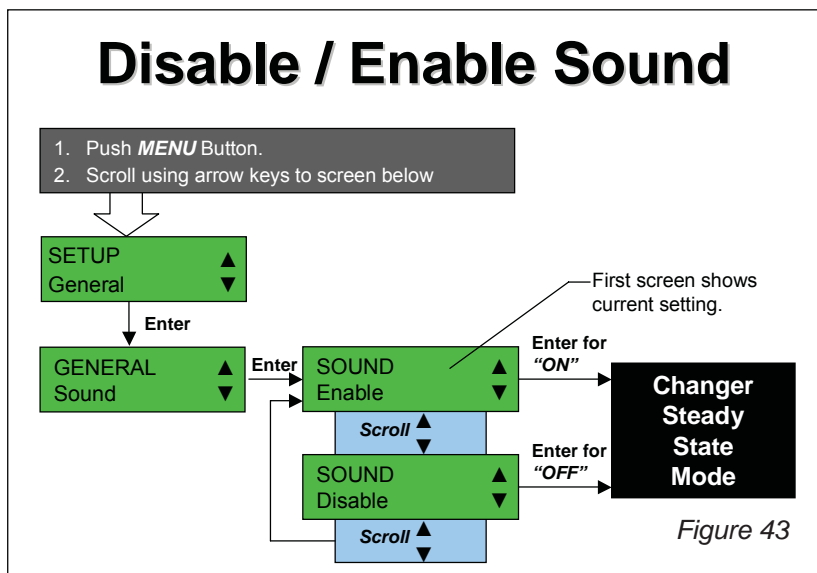

MDB Level

Allows user to set the MDB communications level.

The Guardian 6000XL™ offers two MDB Level setting options:

1. **MDB Level 3 (default setting):** this is the latest communications protocol and provides added functionality. It is recommended for all equipment.
2. **MDB Level 2:** this is an earlier protocol to support machines prior to the early 1990s that do not communicate properly using the MDB Level 3 above.

See Figure 44 for how to change the MDB Level.

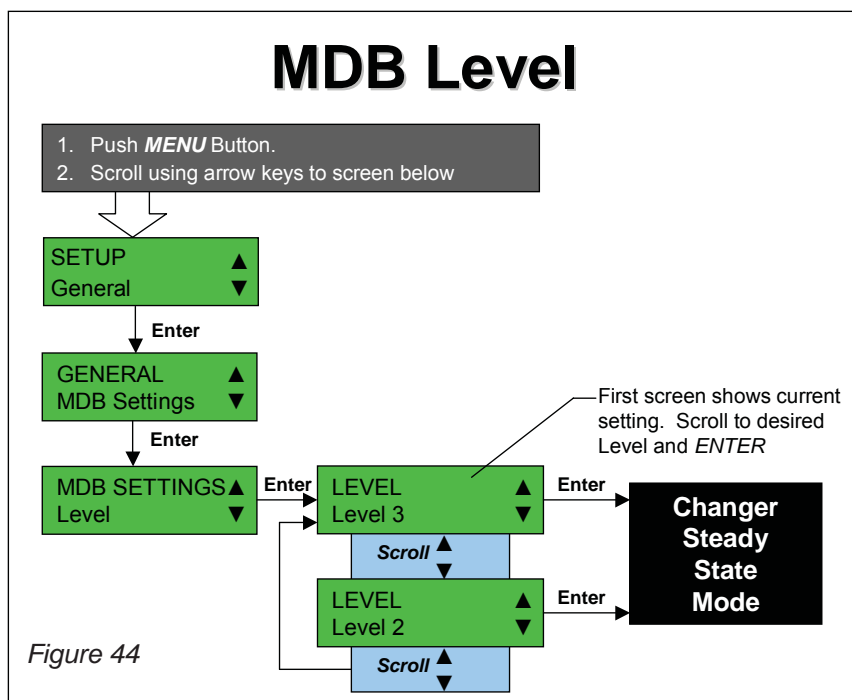

MDB Scale Factor

Allows user to set the MDB scale factor.

The MDB scale factor determines how coins are scaled when reported to the Vending Machine Controller (VMC). Any coin that is not a multiple of the scaling factor set will not be reported to the Vending Machine Controller (VMC) and so will not be accepted.

For example, when MDB scale factor is set to 5, all coins that are a multiple of 5 will be reported.

See Figure 45 for how to change the MDB Scale Factor.

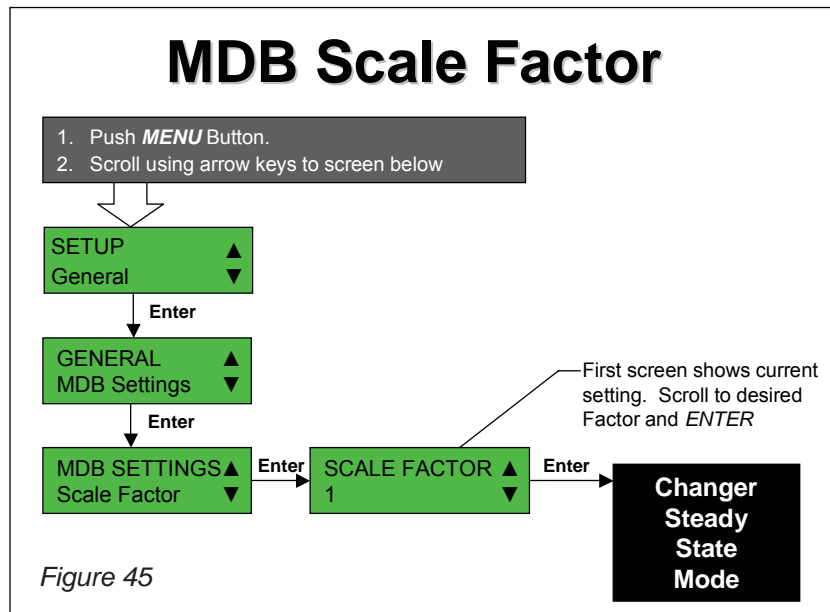

MDB Decimal Point

Allows user to set the MDB decimal point.

The MDB decimal point sets the number of decimal places reported to the Vending Machine Controller (VMC). See Figure 46 for how to change the MDB Decimal Point.

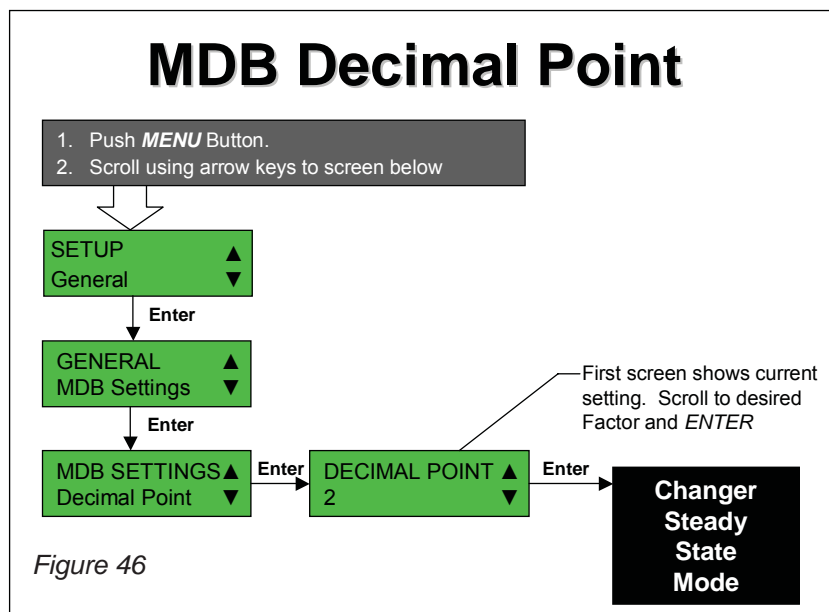



Restore to Factory Default

Allows users to reset the configuration setting to their factory default settings.

See Figure 47 for how to restore the Guardian to factory default settings

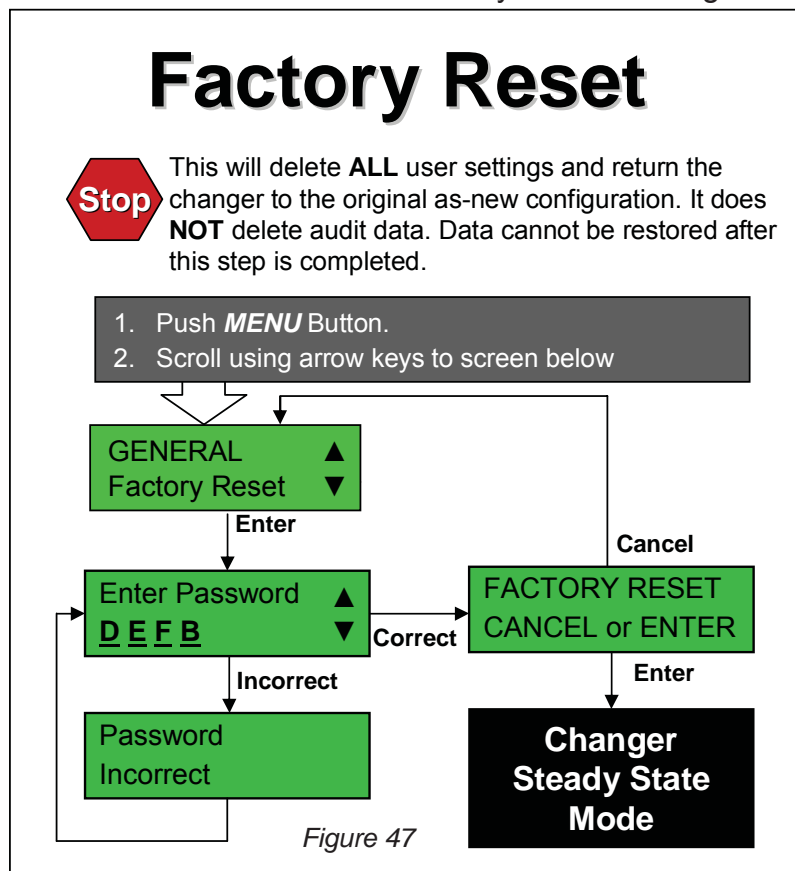

Tube Sense

Allows user to set the circumstances under which the changer will automatically scan for the number of coins in the enabled tubes.

Five options are available:

1. G2 Tube Sense - When enabled the Guardian will simulate the tube sense method used by the Coinco Global 2™ coin changer.
2. Sort Door Close - When enabled (default setting) the changer will use the scanned tube count when the sort door is closed.
3. Cassette Close - When enabled (default setting) the changer will use the scanned tube count when the cassette is closed.
4. Hotkey (A+B) - When enabled (default setting) the changer will scan the tubes and use the scanned tube count when the hotkey (A+B) is pressed.
5. Power Up - When enabled (default setting) the changer will scan the tubes and use the scanned tube count at power up.



The number of coins in the enabled tubes is automatically scanned at power up. It will also automatically override the count if the scanned number of coins in a tube is consistently higher or lower than the manually filled count for that tube.

See Figure 48 for how to change the Tube Sense.

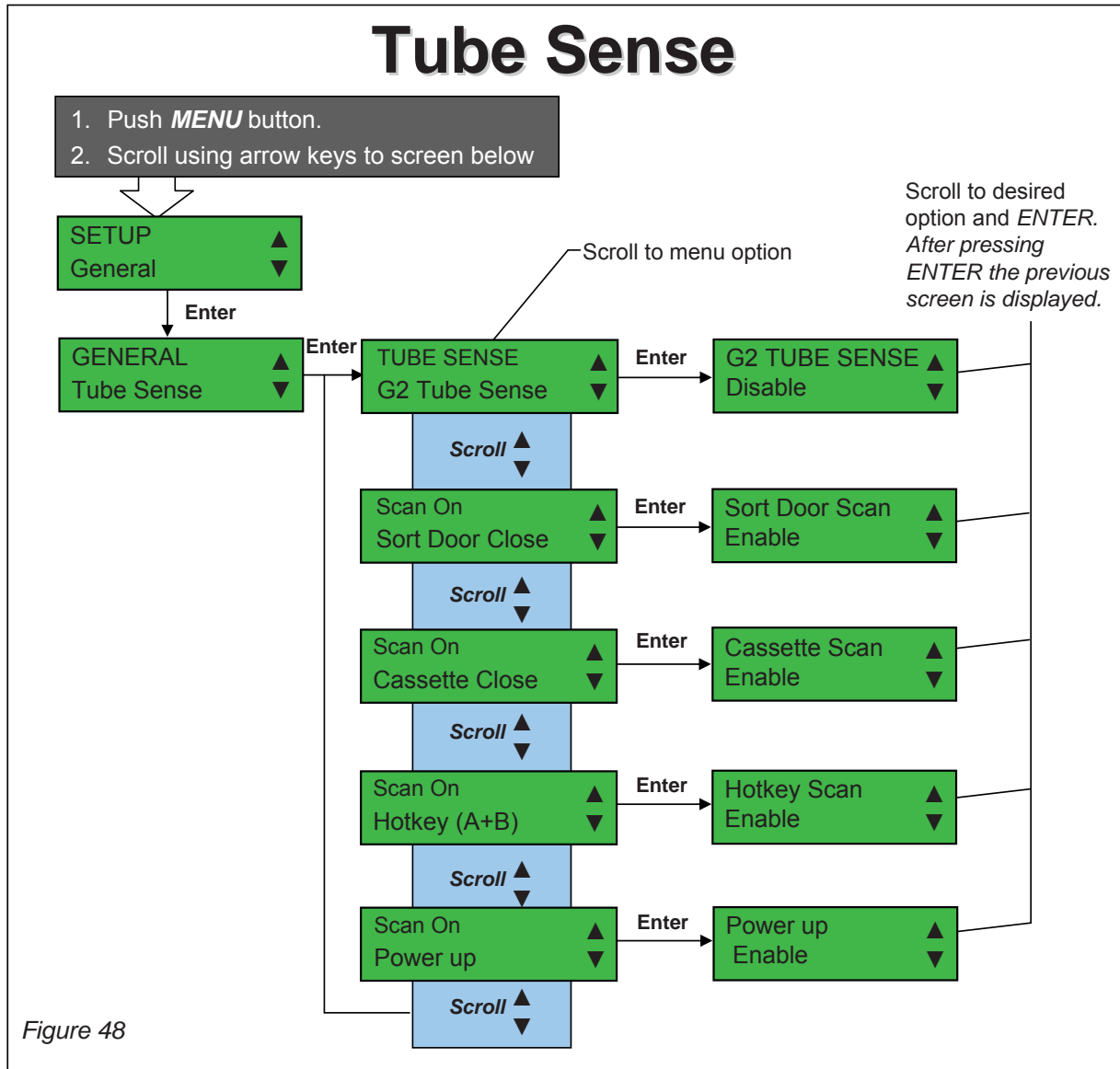

Versions

Allows users to view the current software, executive (if applicable), model and hardware versions for the Guardian.

See Figure 49 for how to display current the software, executive (if applicable), model and hardware versions for the Guardian.

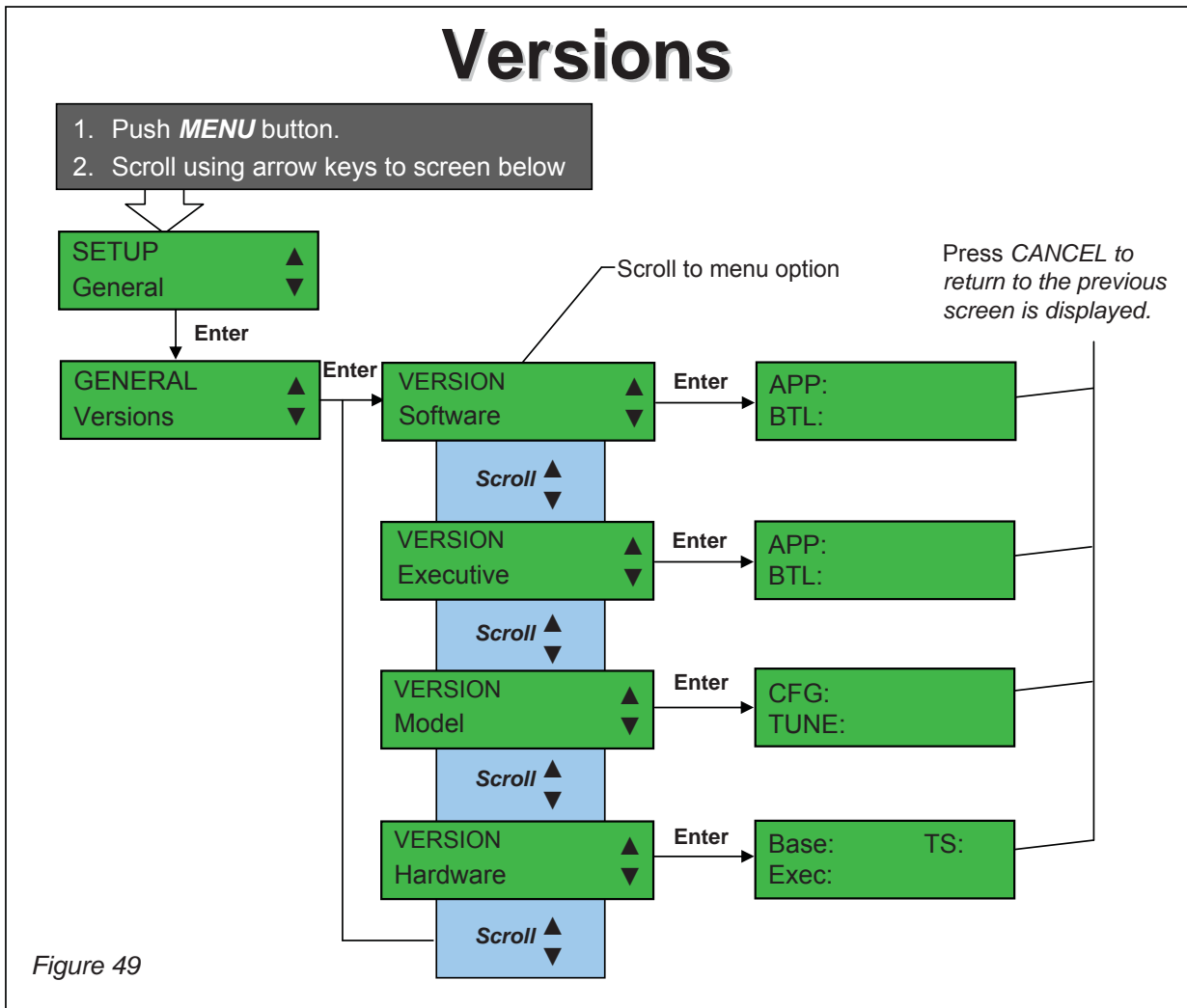

Figure 49

Executive Configuration

This section explains the Executive-specific features of the Guardian 6000XL™ changer.

Figure 50

Executive Menu Structure

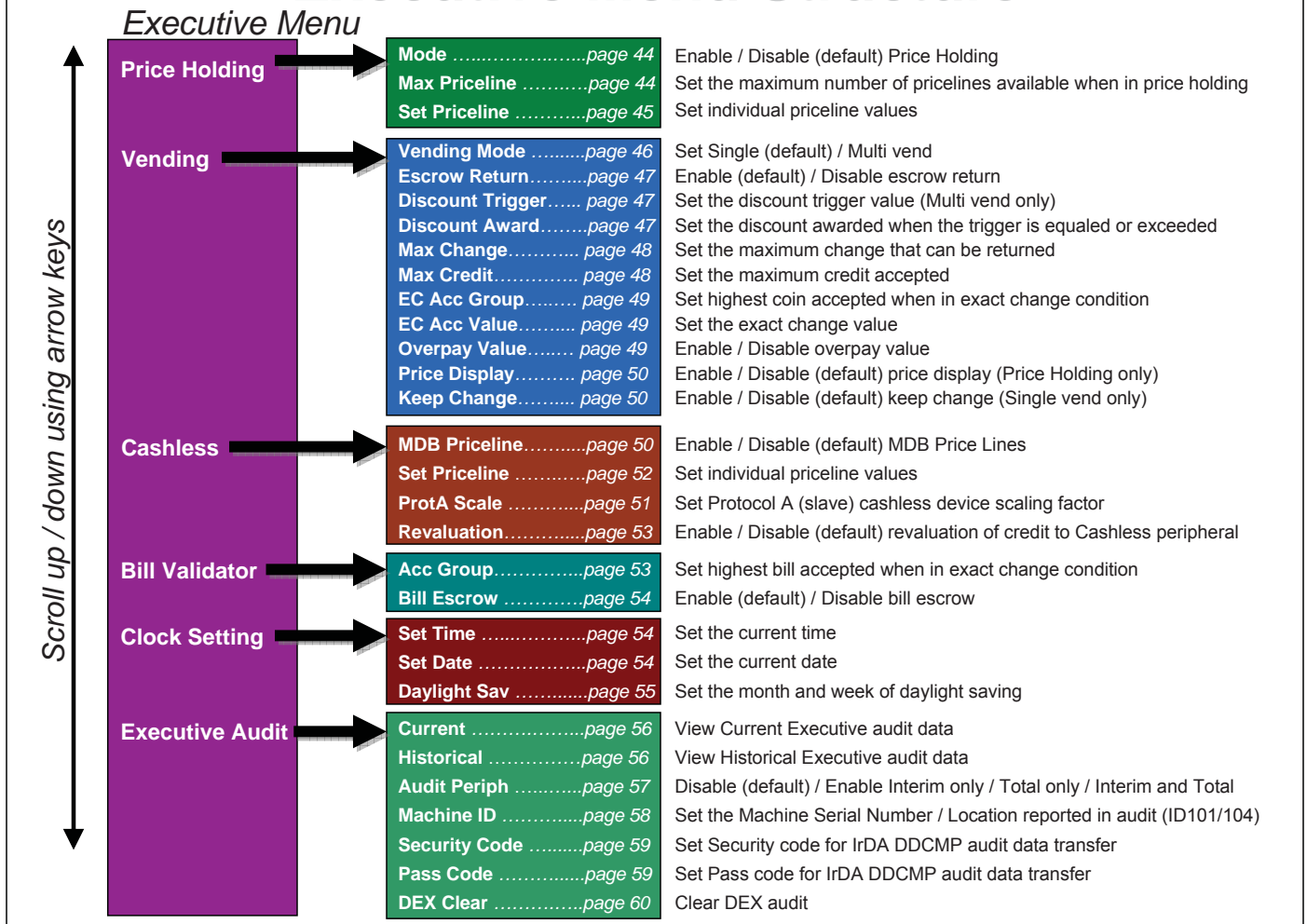

✓ Price Holding

Price Holding enables the user to select whether, when used in Executive mode, the Guardian 6000XL™ changer operates in Price Holding.

When price holding is enabled the price of the selection is stored in the changer (see Pricelines).

When a selection is made on the VMC (Vending Machine Controller) it sends the number of the priceline used as a multiple of the least coin or scaling factor. The changer uses the priceline that corresponds to this number for the vend.

For example, to set an item to use Price Line 2 on the changer when the VMC has a least coin or scaling factor of 5. Set the items price on the VMC to 10.

When price holding is disabled the price of the selection is stored in the VMC (Vending Machine Controller).

See Figure 51 for how to change the mode.

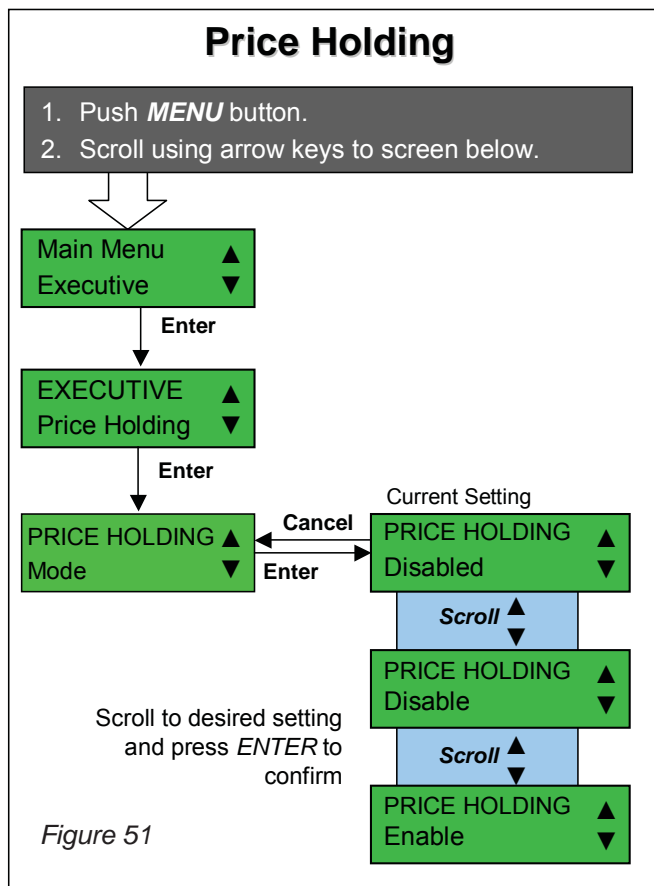

✓ Max Pricelines

Max Pricelines enables the user to set the maximum number of pricelines that are available and reported in audit when price holding mode is enabled.

When in price holding, all prices above the number set in Max Pricelines will be ignored both when vending and reading dex audit (e.g. their PA1, PA2 and LA1 fields will not be reported).

See Figure 52 for how to set the Maximum number of pricelines.

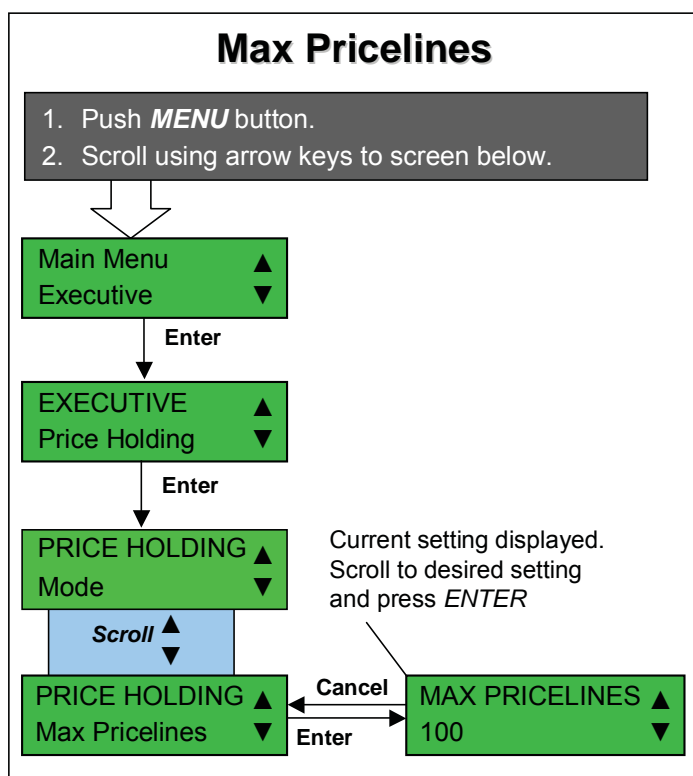

Figure 52



Set Pricelines

Set Pricelines enables the user to set the price for each of the pricelines when price holding is enabled.

Pricelines can be set to a price, disabled or free.

See Figure 53 for how to set the pricelines.

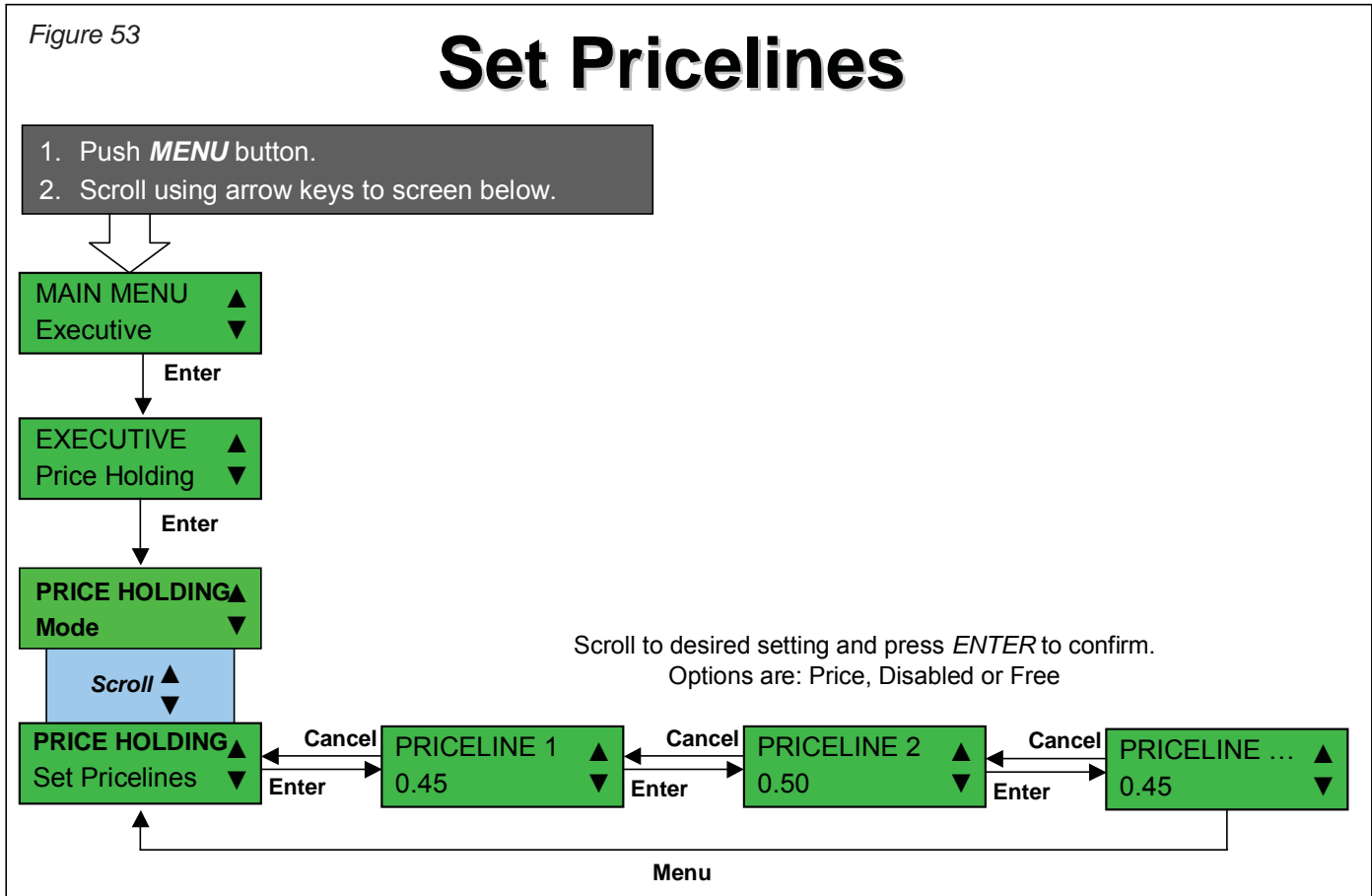

Vending Mode

Vending Mode enables the user to select whether, when used in Executive mode, the Guardian 6000XL™ changer operates in Single or Multi Vend mode.

Single vend mode will automatically return any remaining change after the VMC has signaled a successful vend.

Multi-vend mode will hold the remaining credit until another vend is selected or the customer requests change to be returned by pressing the escrow lever and the change is equal to or less than the Maximum Change. This is to allow customer to make more than one selection without inserting more coins.

Single vend, credit limit – The changer will not accumulate credit above the Maximum Credit value. Above this limit, all coins will be rejected.

Multi-vend, credit limit – This mode is the same as single vend, credit limit except that the *changer* is in Multi-vend mode.

Single vend, price limit – In price holding mode, where Price Holding is enabled, the *changer* will accumulate credit until the credit is higher than the highest priced item set in any of the 100 available price lines. Above this limit, all coins will be rejected.

Multi-vend, price limit – This mode is the same as single vend, price limit except that the *changer* is in Multi-vend mode.

See Figure 54 for how to change the mode.

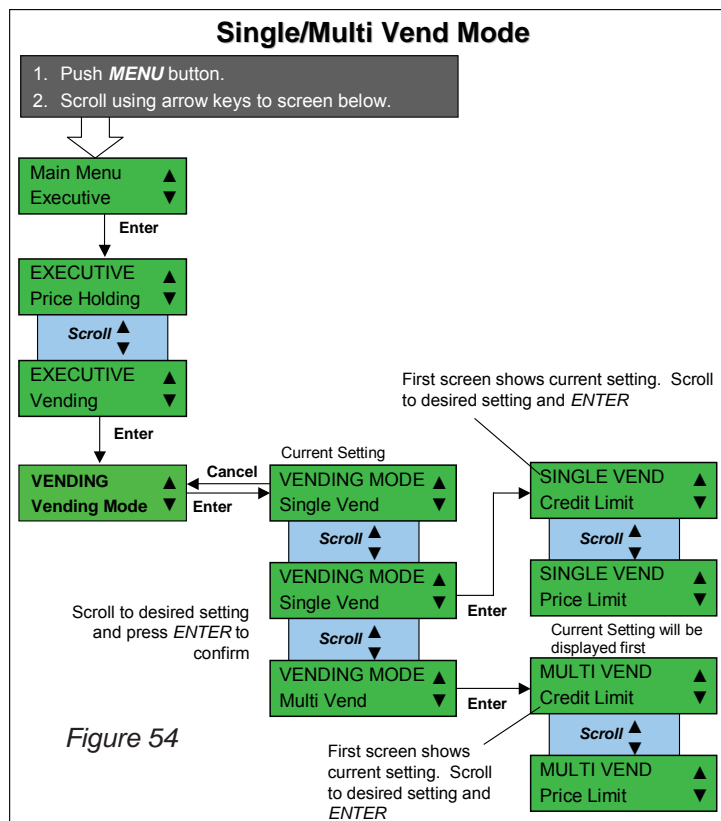

Escrow Return

Escrow Return enables the user to prevent customers from using the vending machine as a source of change for large denomination coins and bills (stacked bills are converted to coin credit).

When Escrow Return is enabled Coins will be returned if customer presses escrow even if no vend has been made.

When Escrow Return is disabled Coins will not be returned until customer makes a vend. If the vend fails in single vend mode, escrow is enabled. In Multi-vend mode, the escrow is enabled after the first vend and below Max Change setting.

See Figure 55 for how to enable/disable Escrow Return.

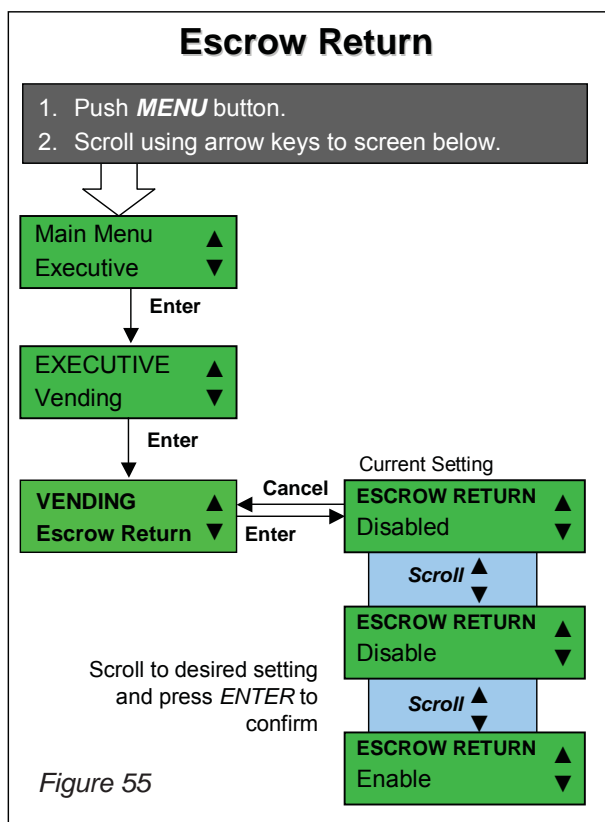

Discount Trigger

Discount Trigger is the value of credit that triggers a Discount Award in multi-vend mode.

When Multi-vend is enabled, the value of discount trigger is essentially the value of the

vends needed to get a discount award.

All vends count towards reaching the discount trigger. Vend value over the trigger value will be accumulated towards the next discount. If the credit falls to zero, the discount is not allowed and the discount starts over with the next transaction.

The exception is if credit falls to zero and the Executive Coin Changer is in price holding mode with at least one vend price set to zero, then the vend value over the trigger value will still be accumulated towards the next discount.

See Figure 56 for how to set the Discount Trigger.

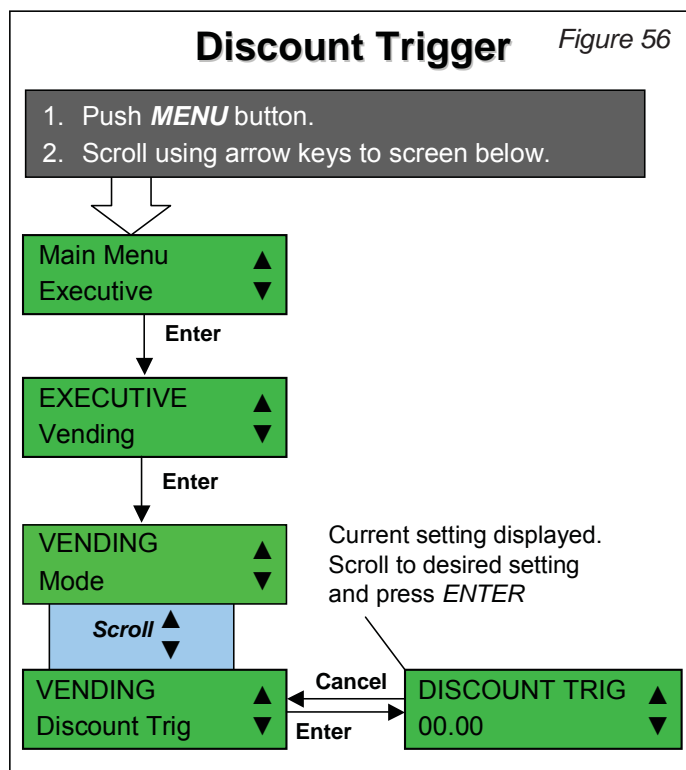

Discount Award

Discount Award is the credit awarded when the Discount Trigger is met or exceeded.

When Multi-vend is enabled a discount award can increase the credit when a preprogrammed purchase value is reached, Discount Trigger.

Discount Award applies for coin, bill and/or cashless credit.

See Figure 57 for how to set the Discount Award.

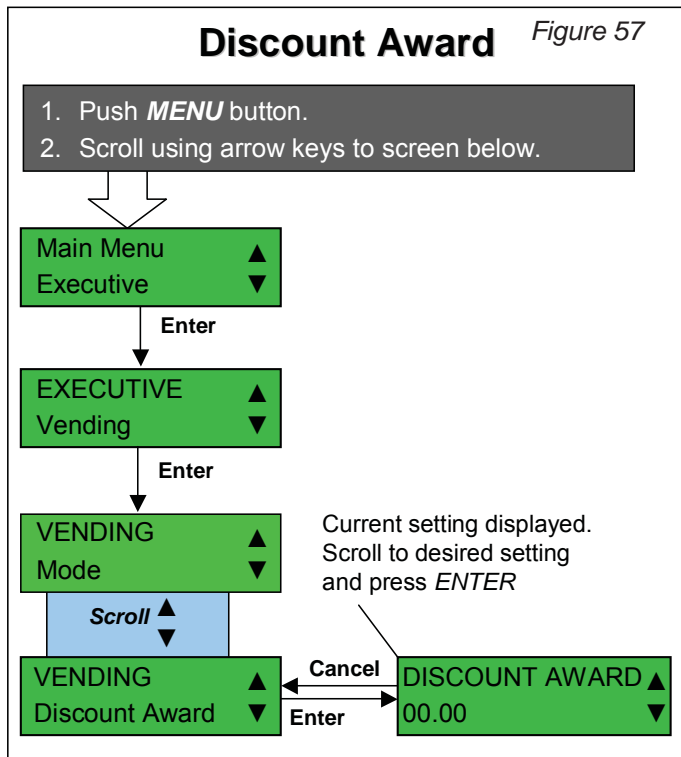

Max Change

Max Change is the maximum change that will be returned by the changer when in Multi-vend mode.

Only operational in Multi-vend mode, this is the maximum change that will be returned to a customer at the end of a transaction.

The changer will not return credit when the escrow lever is depressed unless the credit is under this value, even after a failed vend.

The means that the customer has to continue to make vends until the credit reduces below this value. It will then be possible to return the credit by depressing the escrow lever.

Setting Max Change to the maximum value allows credit to be returned at any time.

See Figure 58 for how to set Max Change.

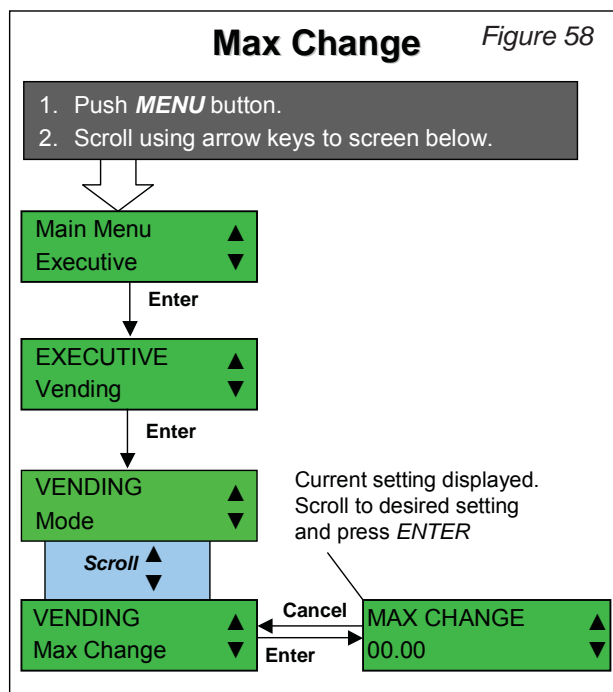

Max Credit

Max Credit is the maximum credit the changer will accept.

Max Credit is the maximum credit allowed. Once credit exceeds this value all coins will be rejected. If set to zero, coins are disabled. Key/Card credit is not be counted towards the maximum credit.

See Figure 59 for how to set Max Credit.

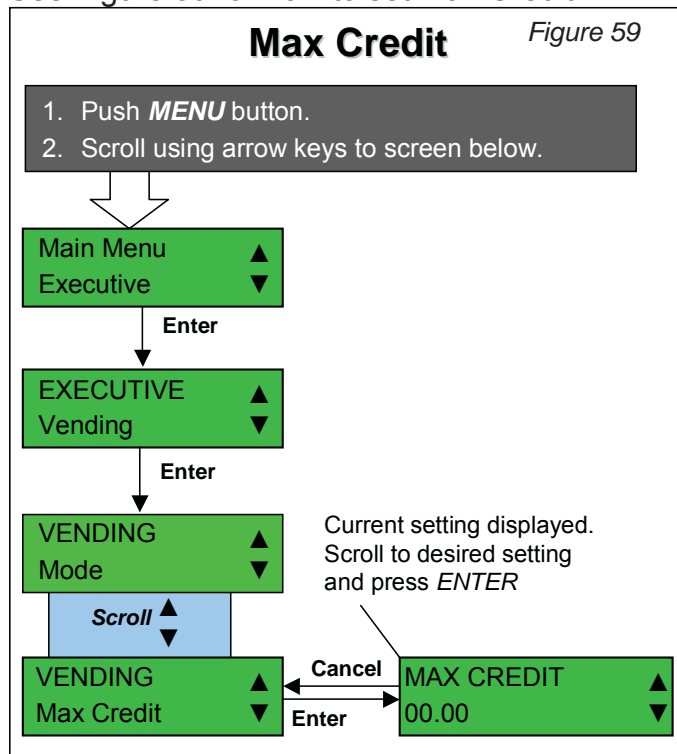

Exact Change Accept Group

Exact Change Accept Group allows the user to set the largest coin value that will be accepted in an exact change condition.

The Exact Change Accept Group is the largest coin value the changer will accept when low on change or unable make change.

This is to help prevent customers from losing money when the exact change light is on and the changer is unable make change.

All coin will be accepted if using a Cashless Payment, such as Key Reader, with revaluation on and a key inserted. See Figure 60 for how to set the Exact Change Accept Group.

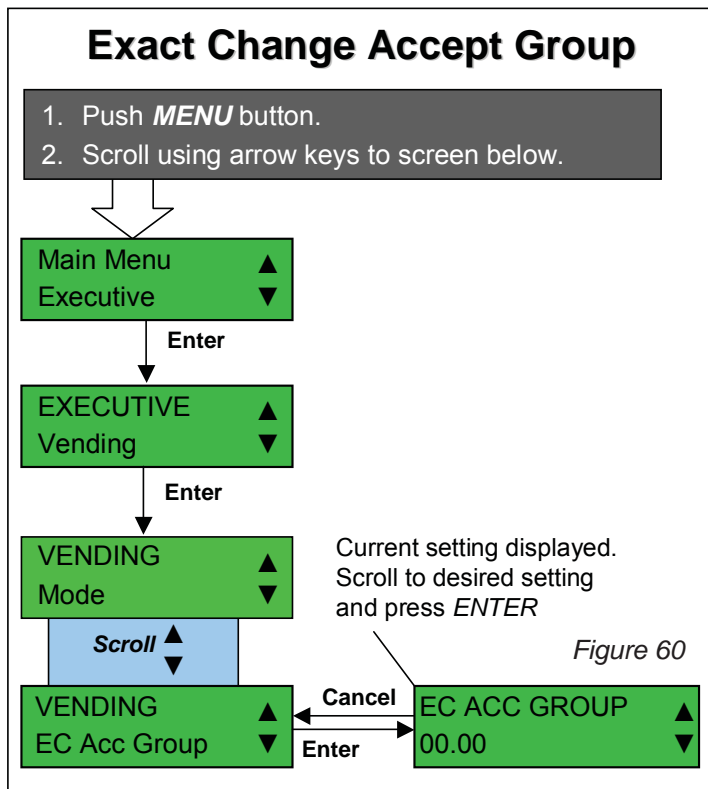

Exact Change Value

Exact Change Value allows the user to the value below which the exact change light will come on.

If the changer cannot make change for the value set in Exact Change Value, then the Exact Change Light is turned ON. The exact change status does not change during a vend. See Figure 61 for how to set the Exact Change Value.

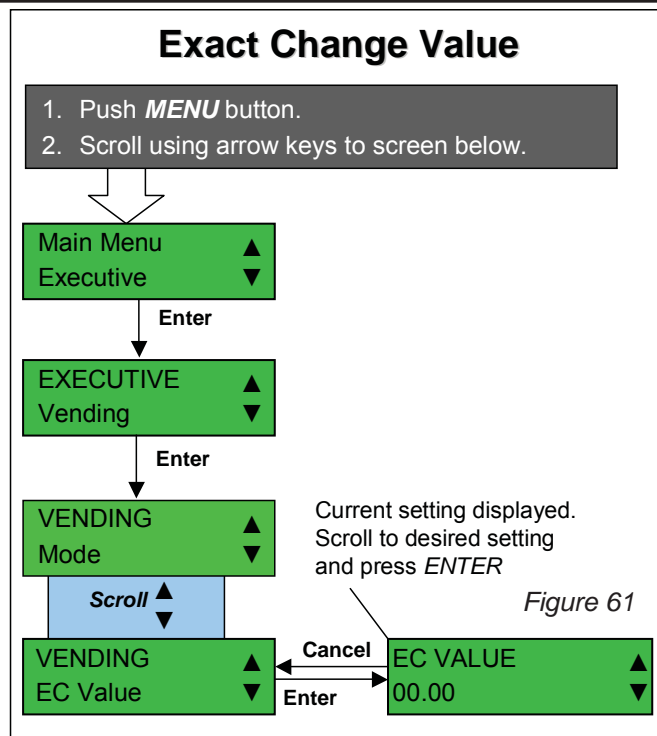

Overpay Value

Overpay Value allows the user to set the value of cashbox coins accepted when in an exact change condition.

The Overpay Value is the value of cashbox coins that will be accepted in an exact change condition.

This value only applies to coins cashbox within the exact change accept group.

See Figure 62 for how to set the Overpay Value.

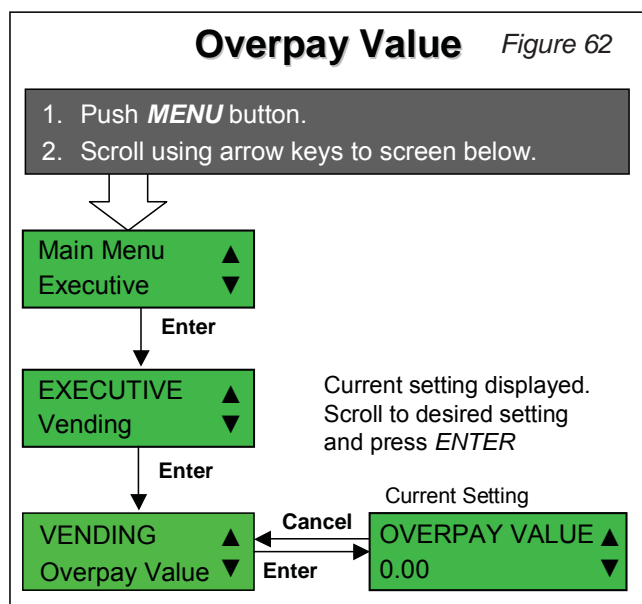

Price Display

Price Display allows the user to enable display of prices when in price holding on the VMC.

When enabled and in price holding the price for the selected price line will be shown on the (if the VMC supports price display mode).

See Figure 63 for how to enable/disable Price Display.

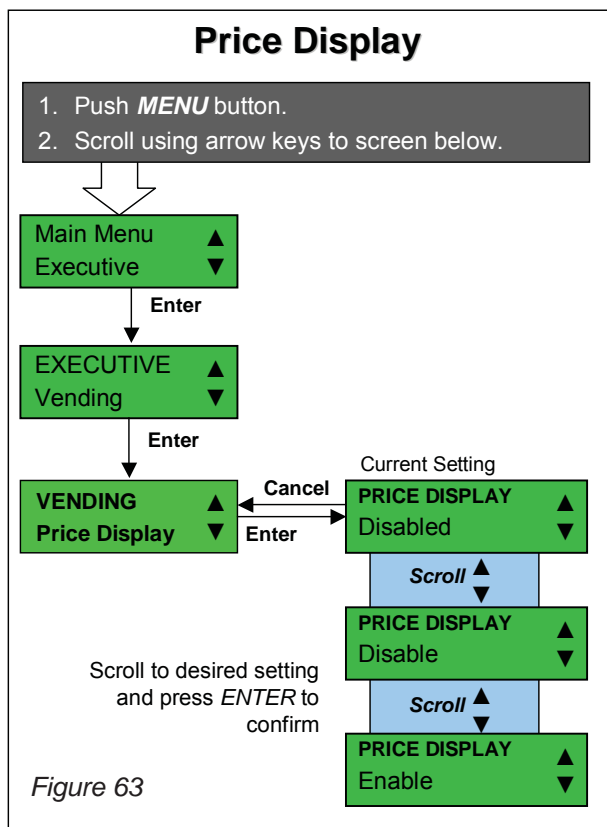

Figure 63

Keep Change

Keep Change allows the user to decide whether change that cannot be paid back is held over when in single vend mode.

When enabled and in single vend mode, any change that cannot be paid back is held over by the changer so that it can be used in the next vend.

When disabled and in single vend mode, any change that cannot be paid back is cleared. The amount of change that is cleared is saved in the audit as overpay.

See Figure 64 for how to enable/disable Keep Change mode.

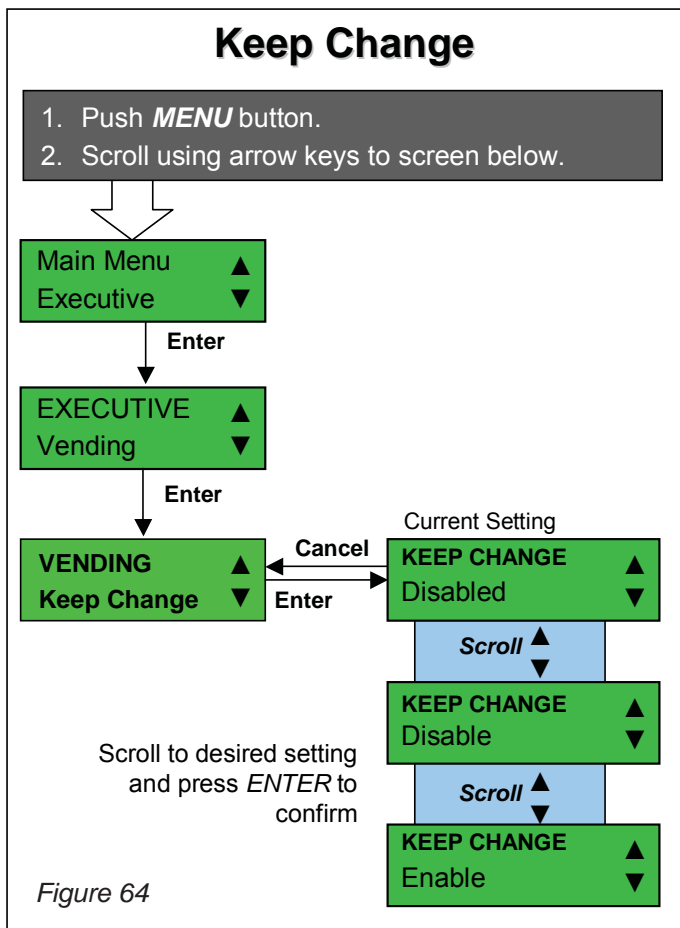

Figure 64

Cashless (MDB) Priceline

Cashless (MDB) Priceline allows the user to decide when in Price Holding whether to use the standard prices or cashless specific prices when vending using MDB Cashless Device.

When enabled, the Cashless (MDB) price lines will be used in price holding mode for all MDB Cashless Device vends. Otherwise all prices in price holding mode will be obtained from price-lines set in the Price Holding menu.

When disabled, all prices in price holding mode will be obtained from pricelines set in the Price Holding menu.

For example, if both price holding and Cashless (MDB) Priceline are enabled, with price line 5 in the Price Holding menu set to 0.50, and price-line 5 in the Cashless menu set to 0.49. Vending using coins will charge a price line 5 selection at 0.50.

Vending using a key (MDB Cashless Device only) will charge a price line 5 selection at 0.49.

When Cashless (MDB) Priceline is enabled, the difference between the coin price and key price will be audited as a discount in the DA5 audit field. See Figure 65 for how to enable/disable Cashless (MDB) Pricelines

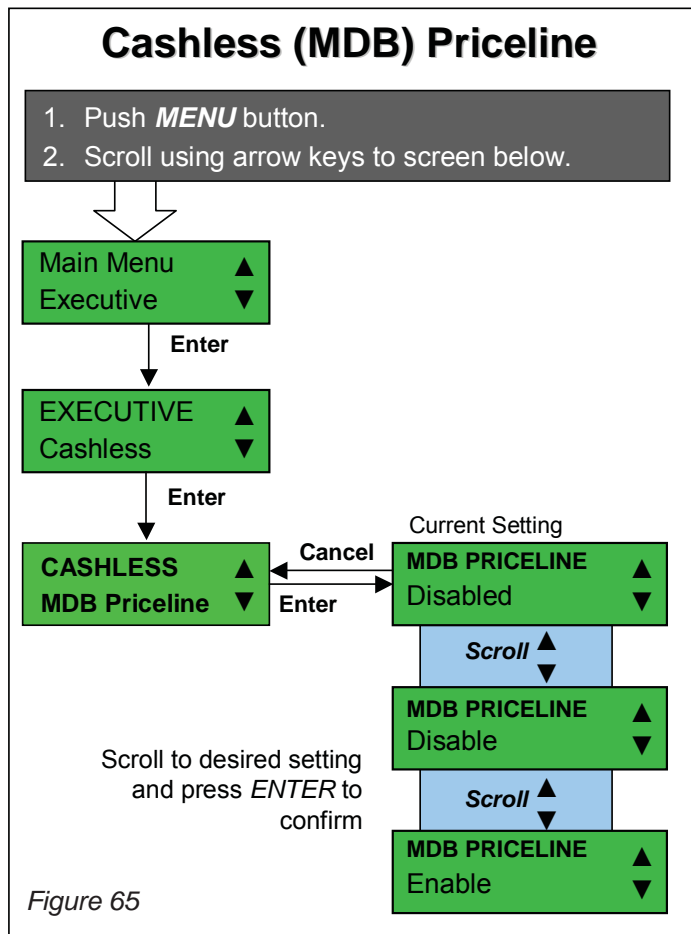

Protocol A Scaling Factor

Protocol A Scaling Factor allows the user to set the scaling factor used by an attached Protocol A Slave Key/Card Reader.

When set to the same value as the changers' scaling factor (see MDB Settings menu) the changer will look for and if present communicate with an attached Protocol A Slave Key/Card Reader.

When set to any other value the changer will not look for an attached Protocol A Slave Key/Card Reader.

See Figure 66 for how to set the Protocol A Scaling Factor

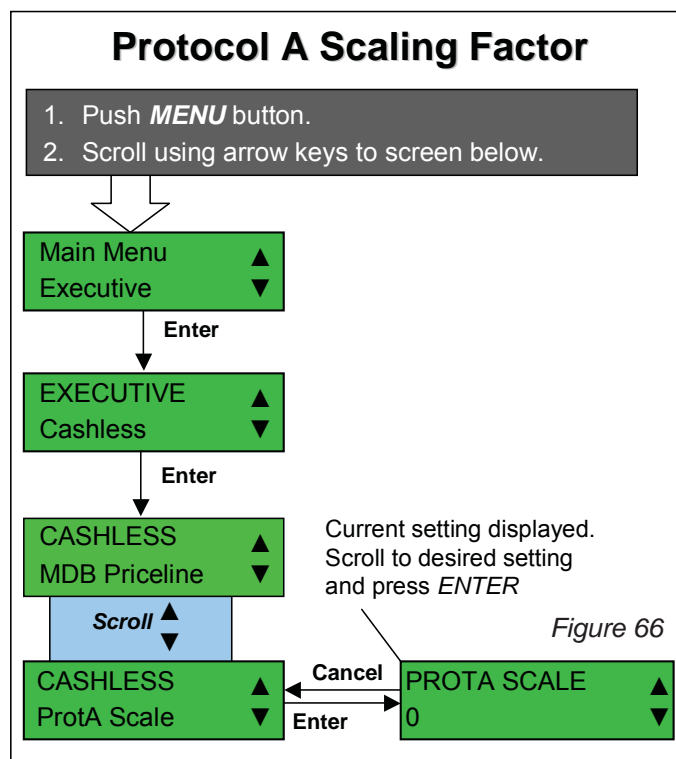

✔ Set (Cashless) Pricelines

Set (Cashless) Pricelines enables the user to set the price for each of the pricelines when price holding is enabled and a MDB cashless device is used.

Pricelines can be set to a price, disabled or free.

See Figure 67 for how to set the pricelines.

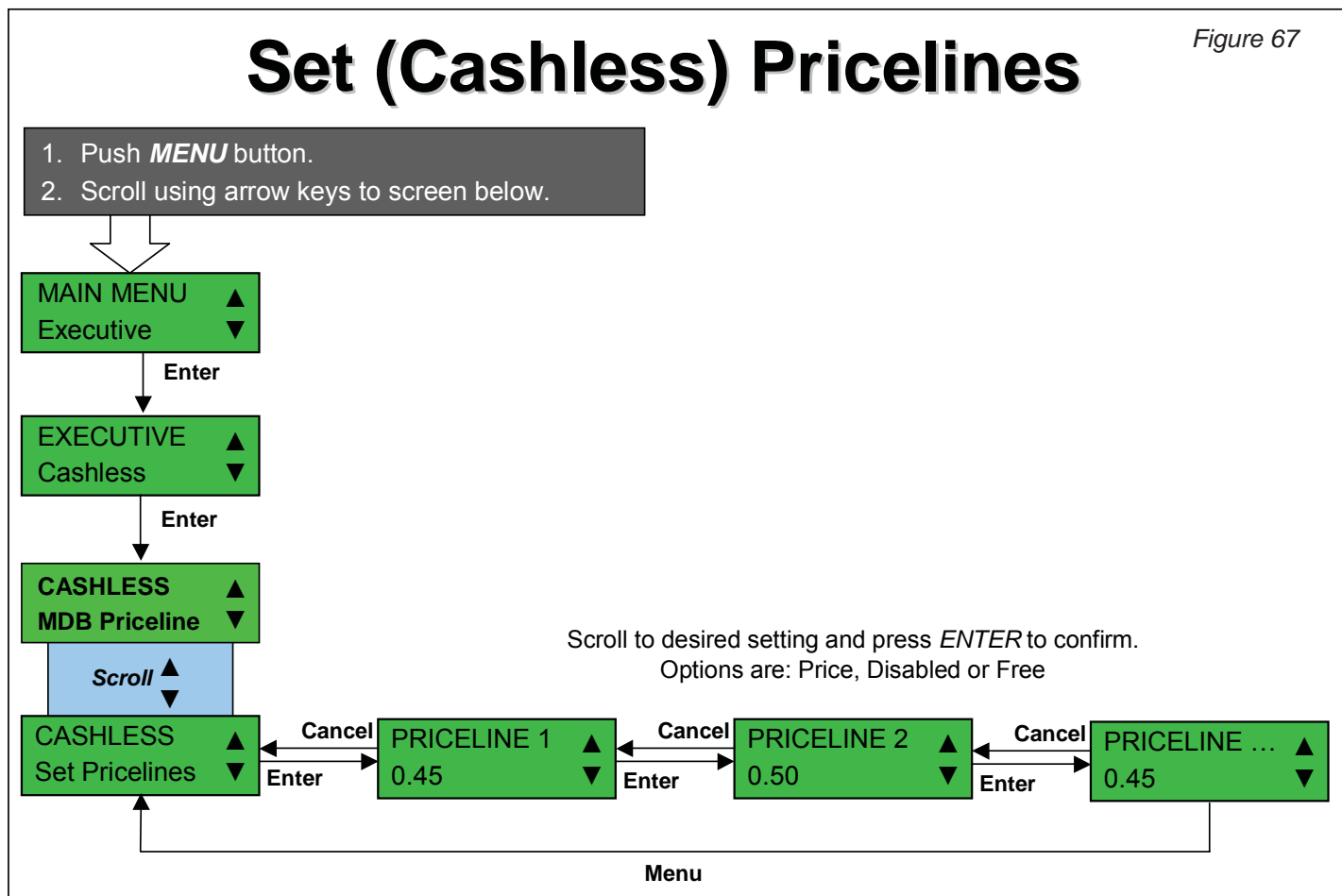

Revaluation

Revaluation allows the user to decide whether revaluation of coin credit to an attached MDB or Executive Slave Key/Card Reader should be enabled.

When enabled, the changer will automatically transfer any coin/bill credit inserted to either an Executive Slave Cashless Payment System or MDB Cashless device regardless of whether the coins/bills or key/card is inserted first. Any credit exceeding the revalue limit of the MDB cashless device will remain as coin credit.

Revaluation is only available in level 2 and 3 MDB cashless devices. Level 1 MDB cashless devices do not support revaluation and so will act as if revaluation is disabled even when it is enabled. See Figure 68 for how to enable/disable Revaluation.

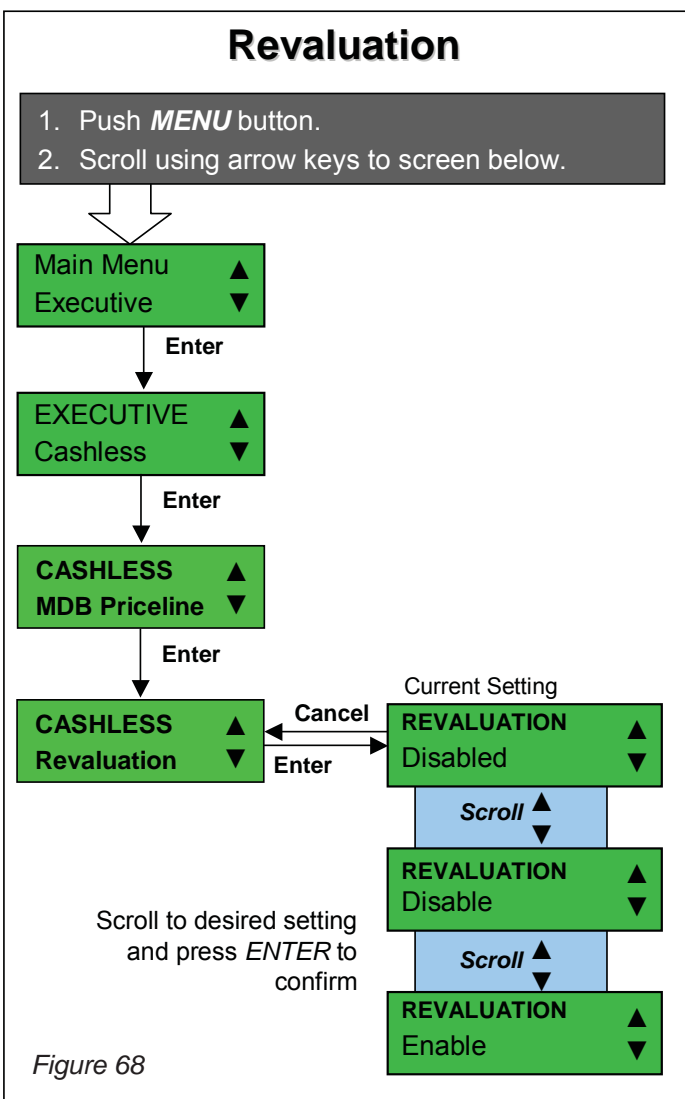

Bill Validator Accept Group

Bill Validator Accept Group allows the user to set the highest bill that will be accepted when in an exact change condition.

The Bill Validator Accept Group is the highest bill the changer will allow a connected MDB Bill Validator to accept when in an exact change condition as determined by the Exact Change Value (see the Vending menu).

All bills above this value will be rejected.

This is to help prevent customers from losing money when the exact change light is on and the changer is unable to make change.

To disable all bills when in an exact change condition set Bill Validator Accept Group to 0.

See Figure 69 for how to set the Bill Validator Accept Group.

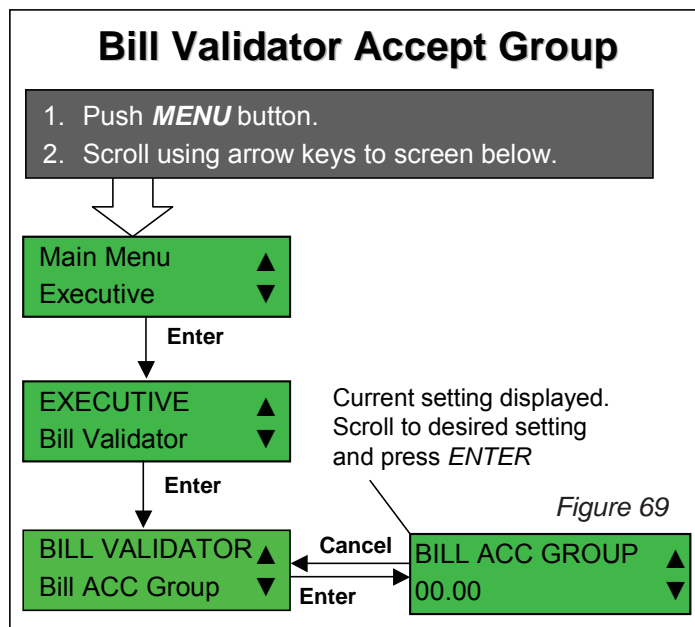

Bill Escrow

Bill Escrow allows the user to decide if bills should be held in escrow when Max Credit is exceeded.

When enabled the last bill which causes the credit to be equal or greater than the Max Credit will be held in escrow.

Bills held in escrow will be returned when vending if they are not required to fulfil the vend price.

For example, if Max Credit is set to 9.95, Bill Escrow is enabled and two bills of value 5.00 are inserted the first will be stacked and the second will be held in escrow. If a vend is then selected of value 4.95, the first bill, already converted to coin credit when stacked, will be used to pay for the vend. The second will be returned.

See Figure 70 for how to enable/disable Bill Escrow.

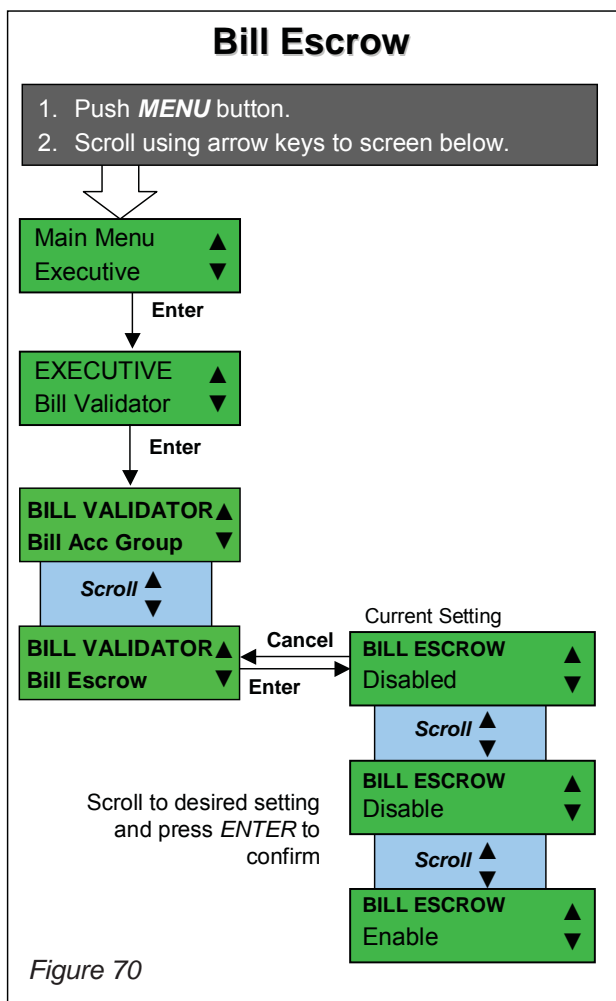

Set Time

Set Time allows the user to set the changers' internal clock used when reporting audit.

Set time allows the time of the internal clock to be set. The current time is reported in the audit field EA303. See Figure 71 for how to set the time.

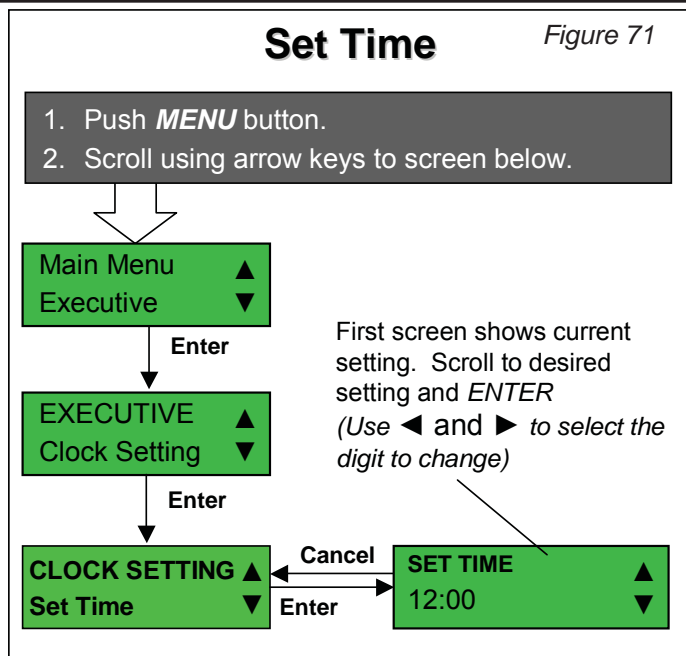

Set Date

Set Date allows the user to set the changers' internal date used when reporting audit.

Set date allows the internal date to be set. The current date is reported in the audit field EA302. See Figure 72 for how to set the time.

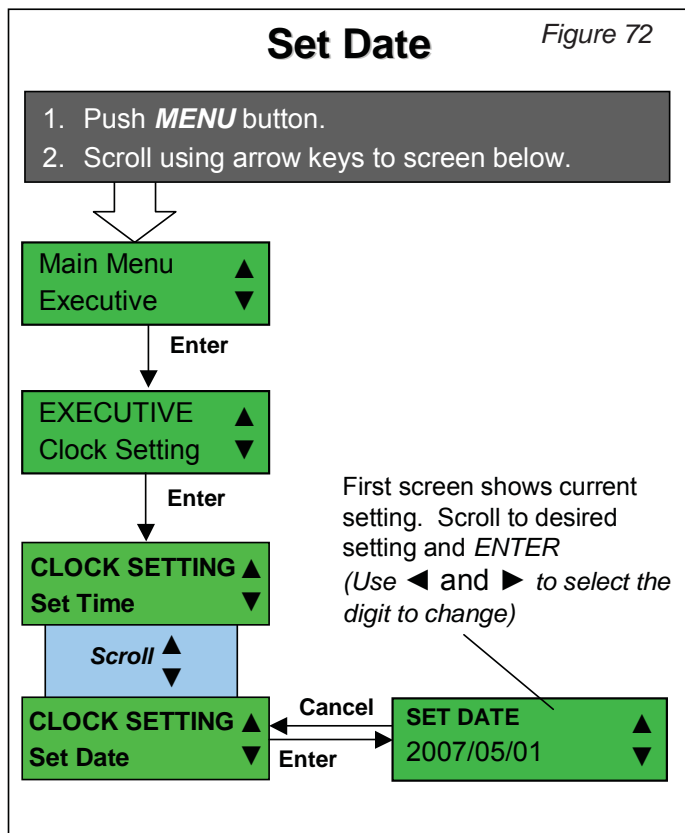

Daylight Saving

Daylight Saving allows the users to set the period of daylight saving.

The Start Month and Week is the month (1 to 12) and week (1 to 5) where Daylight Saving begins.

The End Month and Week is the month (1 to 12) and week (1 to 5) where Daylight Saving ends.

If either value (Month or Weekend) is set to 0 daylight saving is disabled. If Week is set to 5 it will switch on the last weekend of the month.

See Figure 73 for how to set daylight saving.

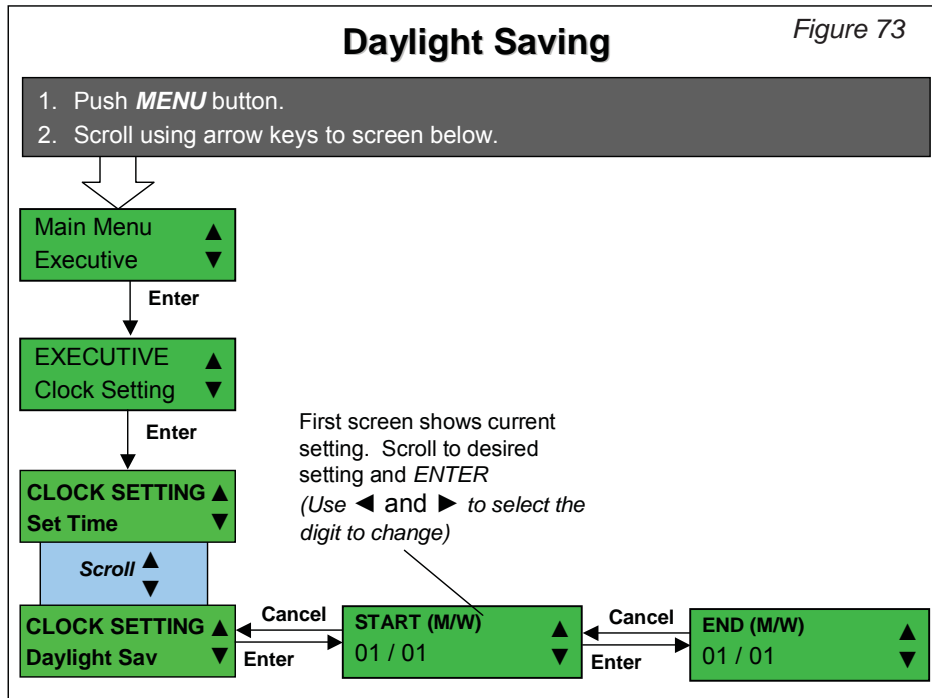

Executive Audit - Current and Historical

The Guardian features a means of tracking and reporting all sales carried out in Executive mode. Executive Audit data consists of two types of data: 1) Current Data, and 2) Historical Data.

- Current (Resettable) Data:** consists of changer data stored since the last user reset.
- Historical (Resettable) Data:** consists of changer data stored since initialisation.

See Figure 74 for how to view Current audit and Figure 75 for how to view Historical audit.

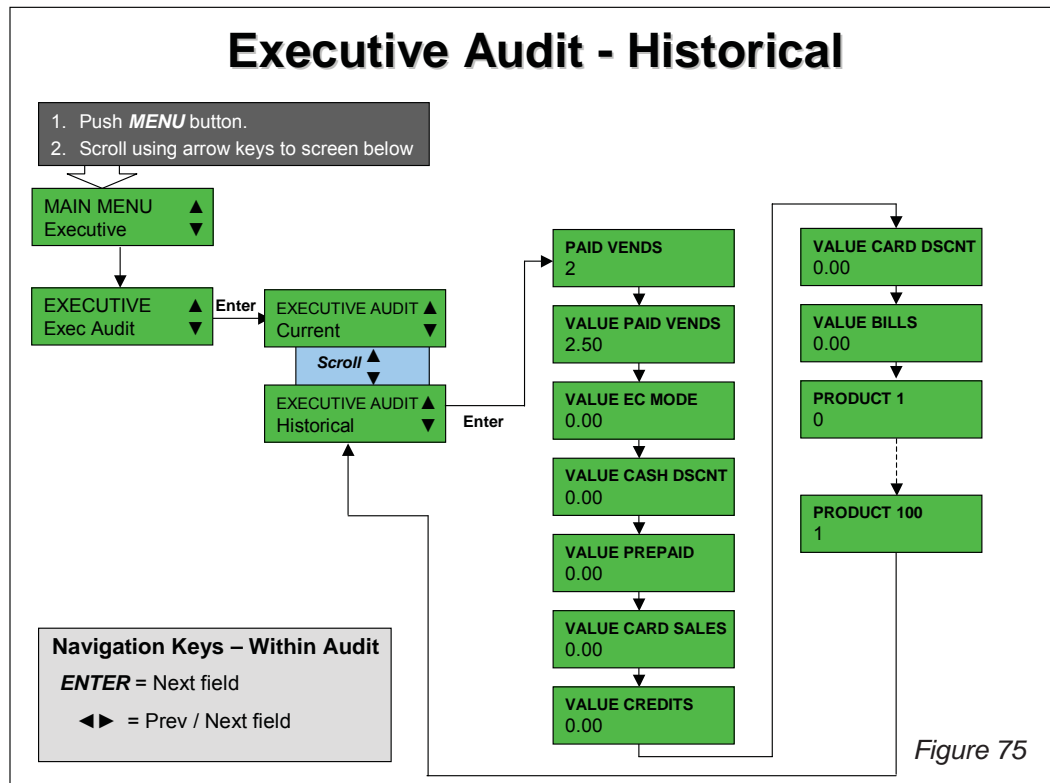
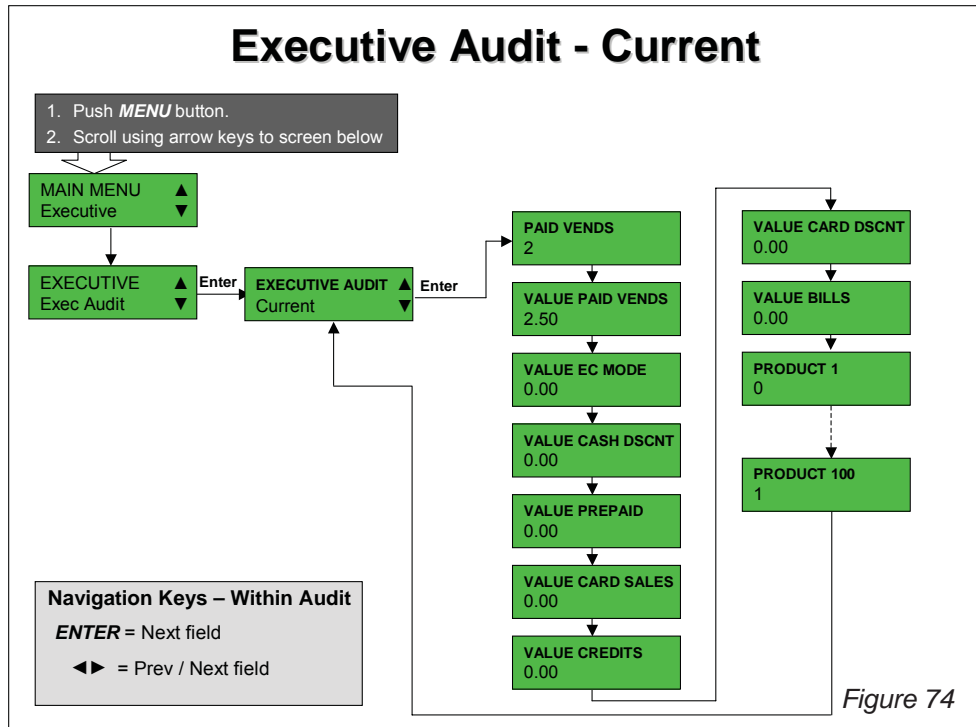

Audit Peripheral

Allows the user to enable support for a Executive Audit Storage Unit (ASU)

When not disabled, Executive audit data commands will be sent whenever a coin is inserted, a coin is dispensed, or a vend occurs.

The following options are available:

- 0 Disable audit peripheral
- 1 Enable audit peripheral, interim only.
- 2 Enable audit peripheral, total only.
- 3 Enable audit peripheral, interim and total.

The only difference between the data sent to interim and total is the address it is sent to. The receiving audit storage capable device handles accumulation of the data.

Note if Audit Peripheral is enabled without a Executive device capable of accepting Audit commands attached, it is possible that the polling of the unattached Audit Storage Unit will cause a 3 second period where no coins are accepted every 30 seconds.

The following Audit Storage Unit (ASU) addresses are supported:

	Interim	Total
Money to Tubes	52	7
Money to Cashbox	54	9
Money dispensed as change	56	11
Money dispensed as inventory	58	13
Value of overpay	60	15
Value of pay vends	62	17
Value of pay vends EC	64	19
Value of discount vends	66	21
Money decremented from debit card	68	23

Money decremented from debit card will only be sent when operating a slave Cashless Payment Peripheral (CPP). It will not be sent for an MDB cashless device.

See Figure 76 for how to enable the audit peripheral

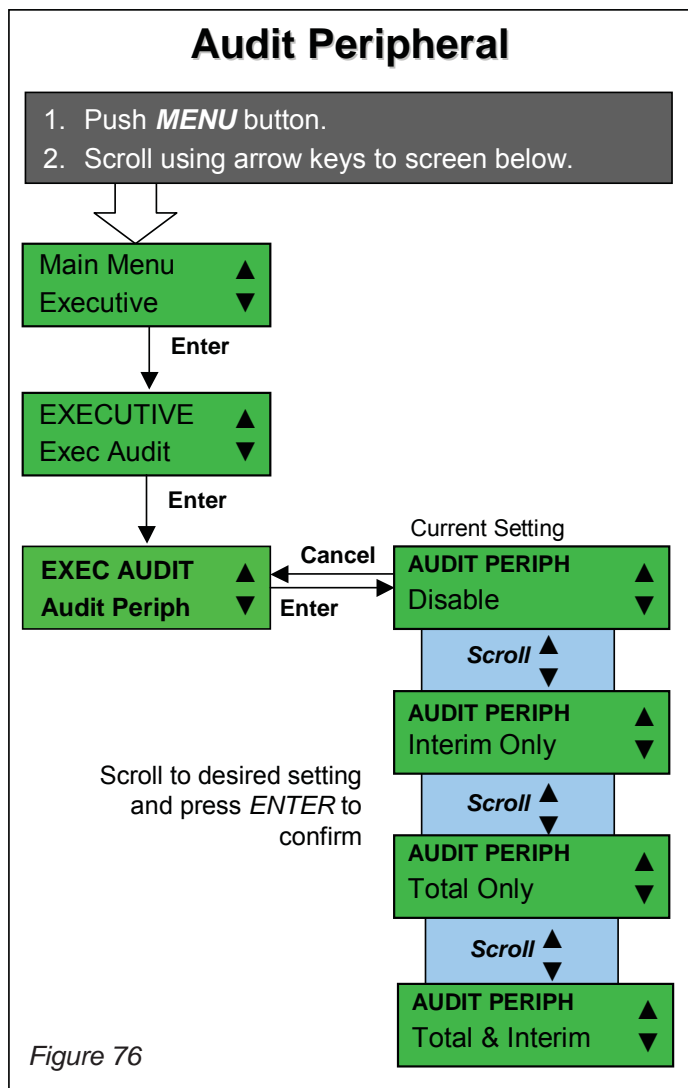

Machine ID

Allows the user to set the last eight digits of the: 1) machine serial number and 2) machine location.

1. Machine Serial Number: These addresses represent the least last eight digits of the identification field ID101 and can be set between 0 and 9.

2. Machine Location: These addresses represent the least last eight characters of the identification field ID104 and can be set between 0 and 9.

See Figure 77 for how to the Machine ID.

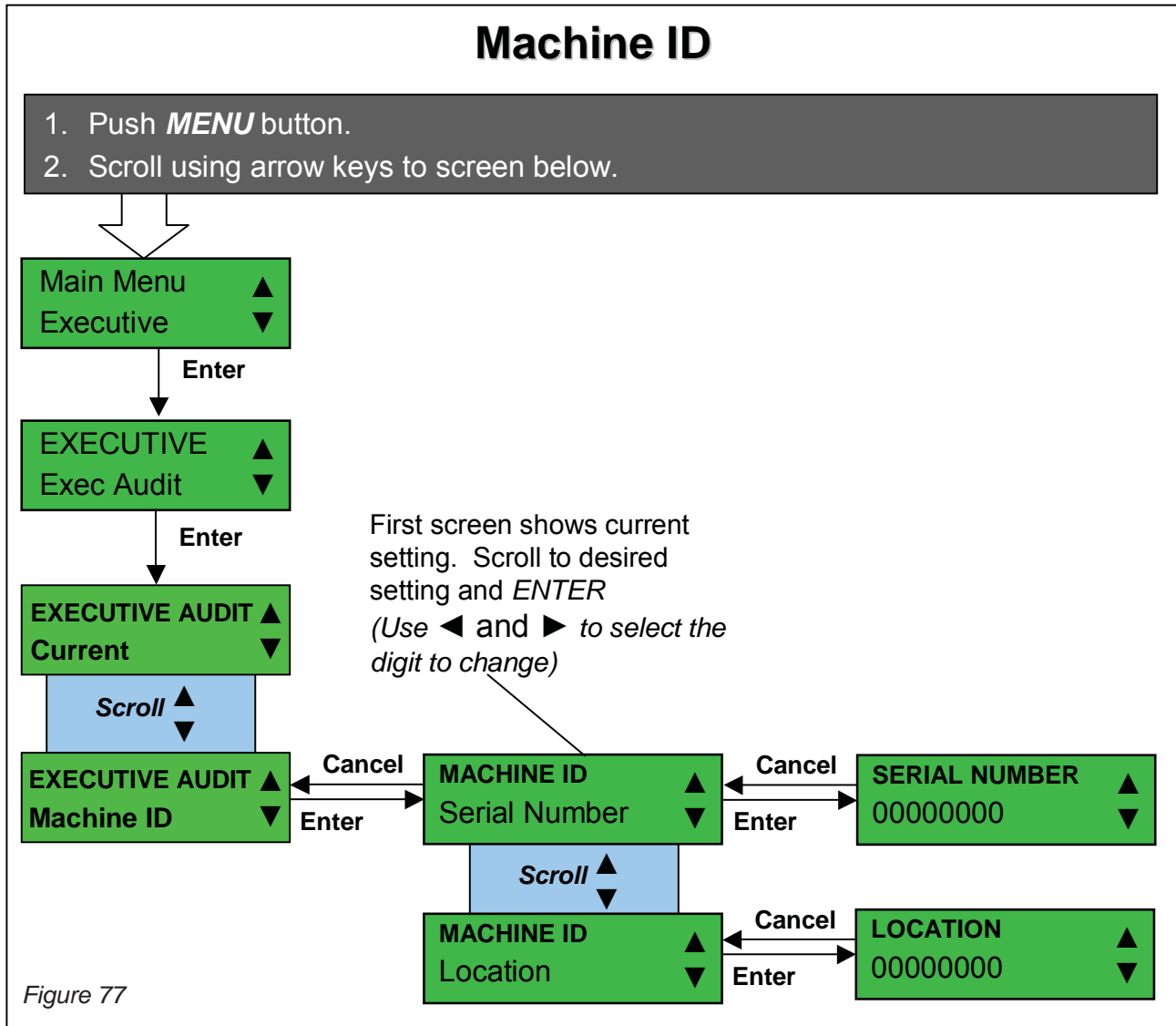

✓ Security Code

Allows the user to set the security code used for collection activation of audit over the DDCMP protocol.

Security code allows the security code to be set as defined in version 6 of the EVA-DTS specification.

See Figure 78 for how to set the security code.

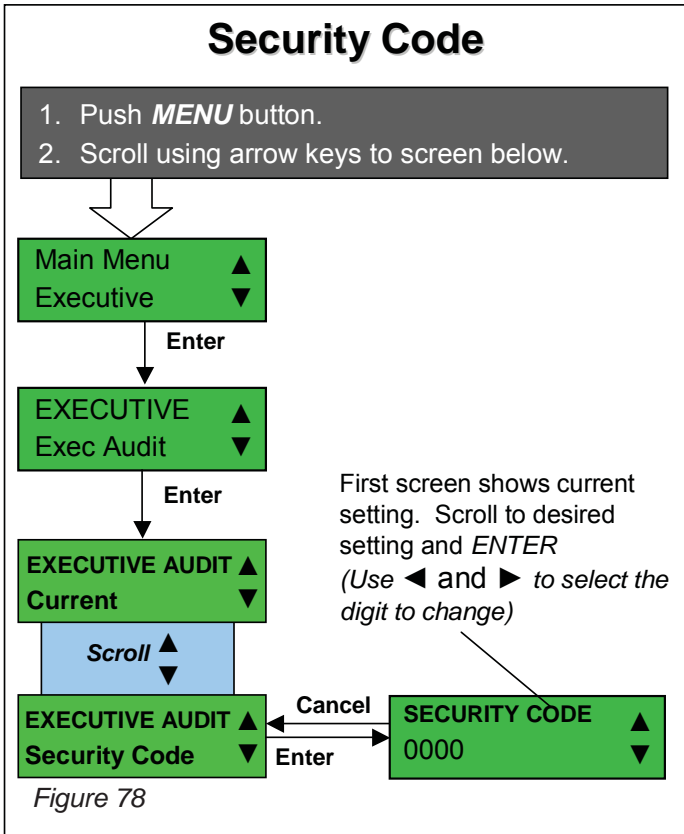

✓ Pass Code

Allows the user to set the pass code used for collection activation of audit over the DDCMP protocol.

Pass code allows the pass code to be set as defined in version 6 of the EVA-DTS specification.

See Figure 79 for how to set the pass code.

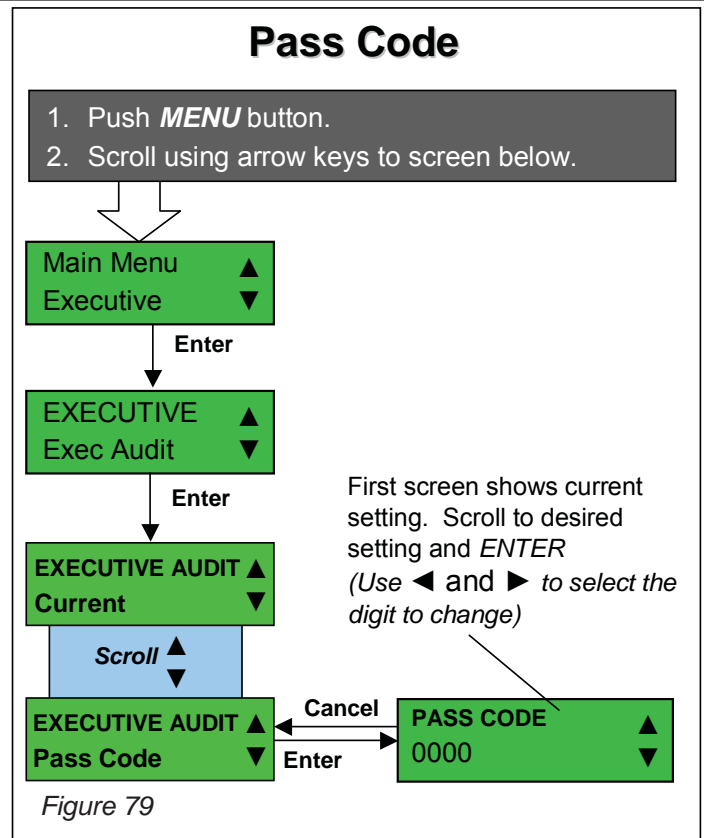

DEX Clear

Allows the user to clear the Executive DEX Audit.

Dex clear allows the Executive DEX audit to be cleared once the password has been entered.

See Figure 80 for how to clear the Executive DEX audit.

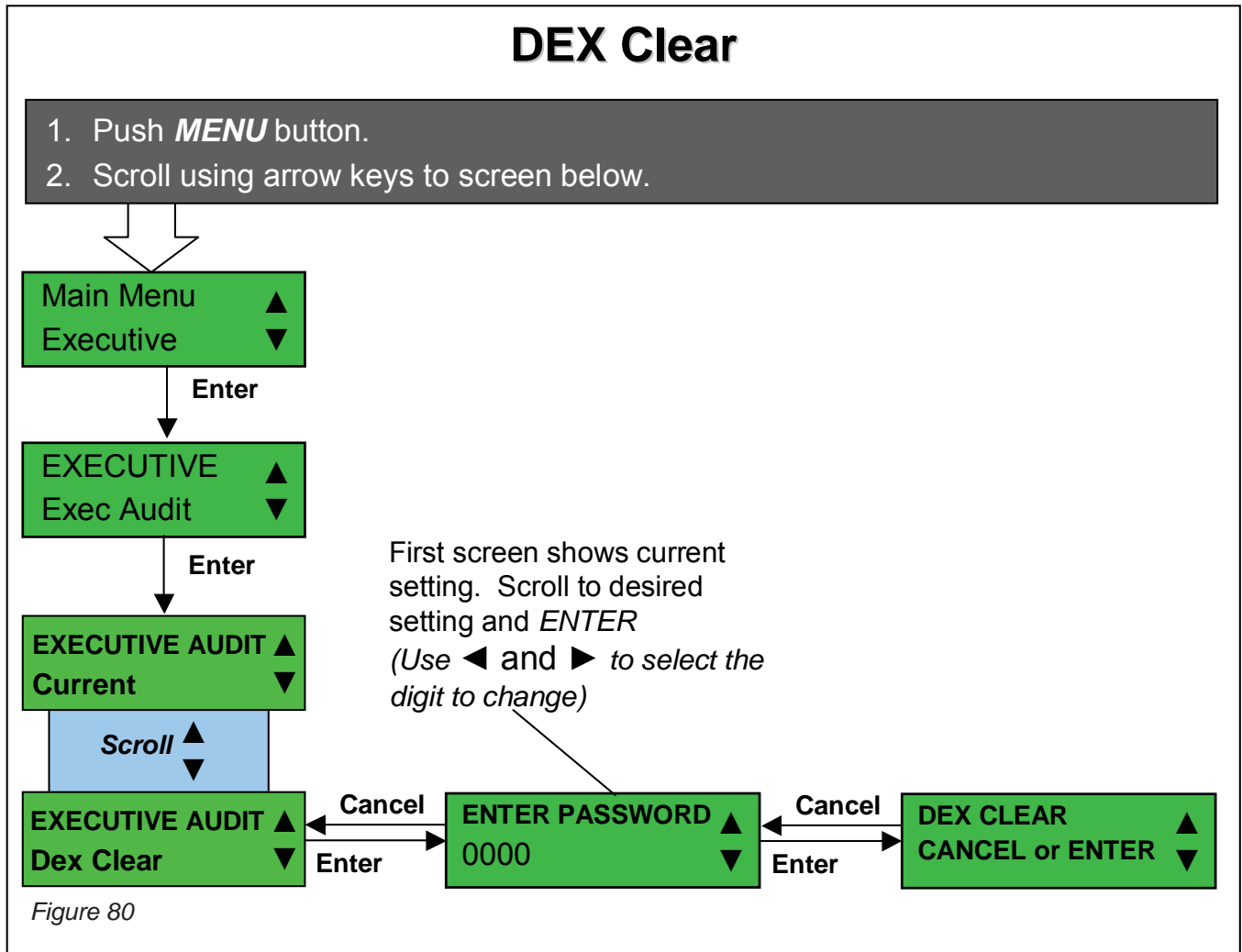

SECTION 7: MAINTENANCE

Routine Maintenance

Routine maintenance will improve the performance and extend the life of your Guardian changer while reducing the need for more involved repairs. Frequency of maintenance will depend on environment and number of transactions.

Cleaning

The majority of your Guardian 6000XL™ changer is manufactured from high-quality industrial grade plastic and should be cleaned with a warm water and detergent solution.

⊘ CAUTION:

- Never submerge the changer in water
- Do not use petroleum solvents, steel wool, scouring pads, or metal brushes for cleaning.
- Do not spray any part of the changer with any type of lubricant.

Since all coins share a common inlet and coin ramp, heavy usage or a dirty environment can result in dirt build-up in the acceptor. Clean the coin ramp by opening the acceptor gate to the right. Hold the gate to prevent it from snapping back. Wipe the exposed coin ramp and inner surfaces with a damp cloth. For excessively dirty units, use a damp cloth and mild detergent.

⊘ DO NOT SUBMERGE UNIT IN WATER!

Maintenance / Disassembly

Removing the Acceptor

1. Remove the acceptor from the changer housing by pressing the acceptor latch to the right on the front of the acceptor and then pull the escrow lever towards you, away from changer housing. See Figure 82.
2. Disconnect the acceptor's ribbon cable from the changer housing. Lift the acceptor slightly to free the lower acceptor studs from the changer housing. Place the acceptor in a clean, dry area. See Figure 83.

Changer Components

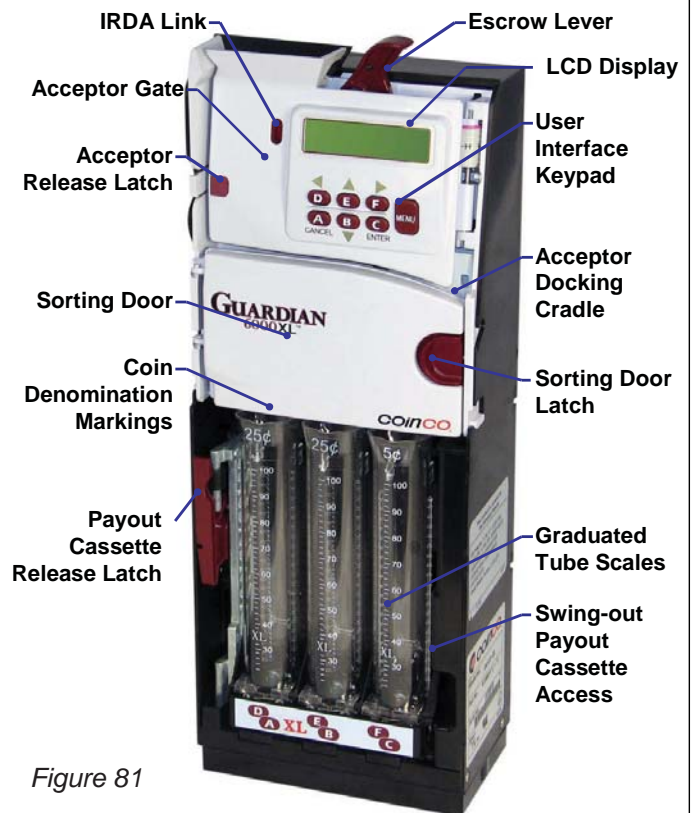

Figure 81

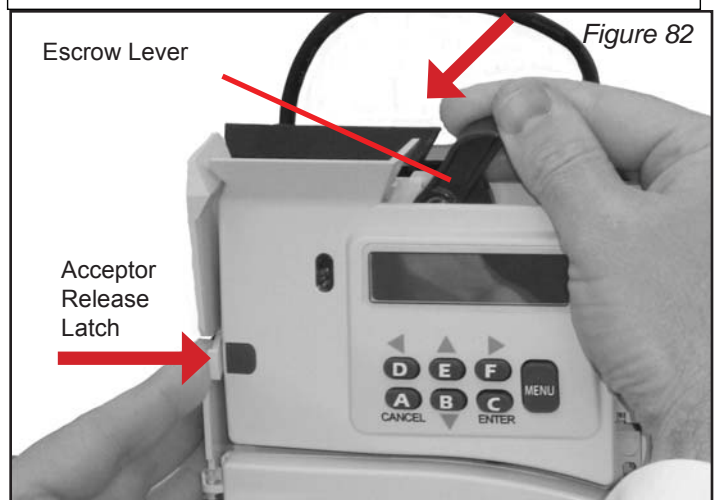

Figure 82

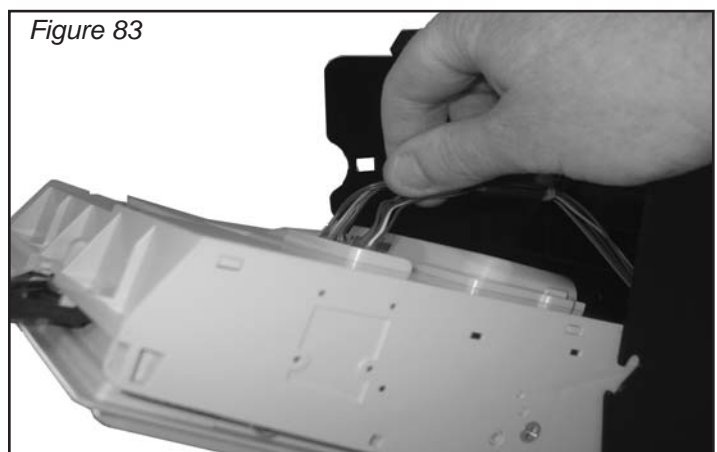
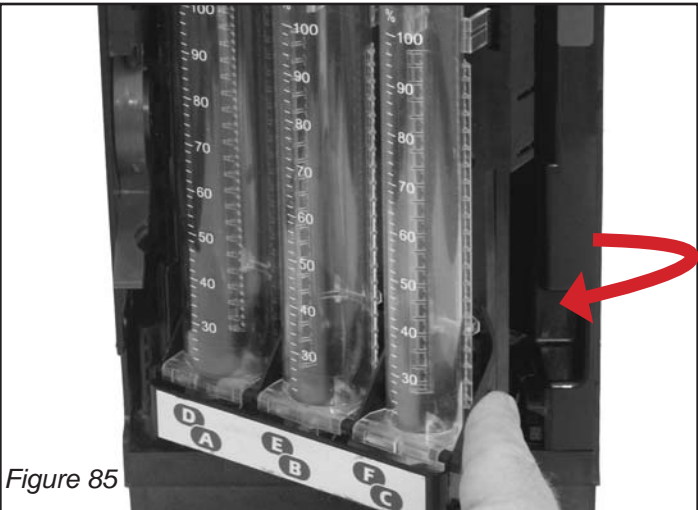
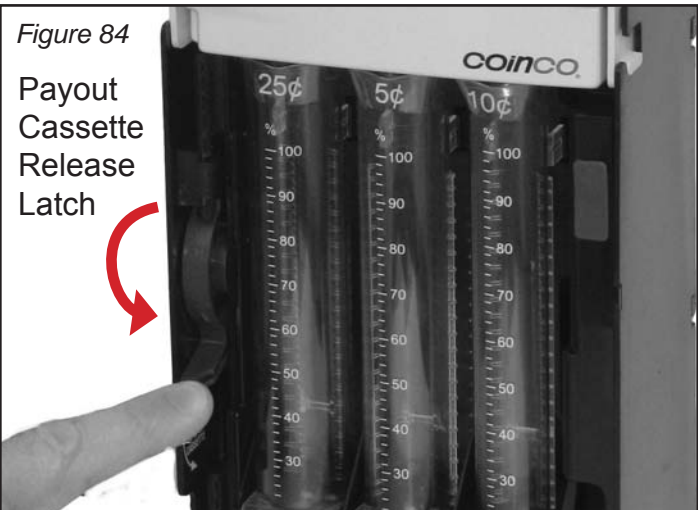

Figure 83

Removing the Coin Tube Cassette

- 3. Rotate the Payout Cassette Release Latch downward to open the coin payout cassette. Pivot the payout cassette out of the changer housing to access the coin tubes. See Figures 84 & 85.



- 4. Lift the cassette straight up (including the double-hinge) to remove. See Figure 86.

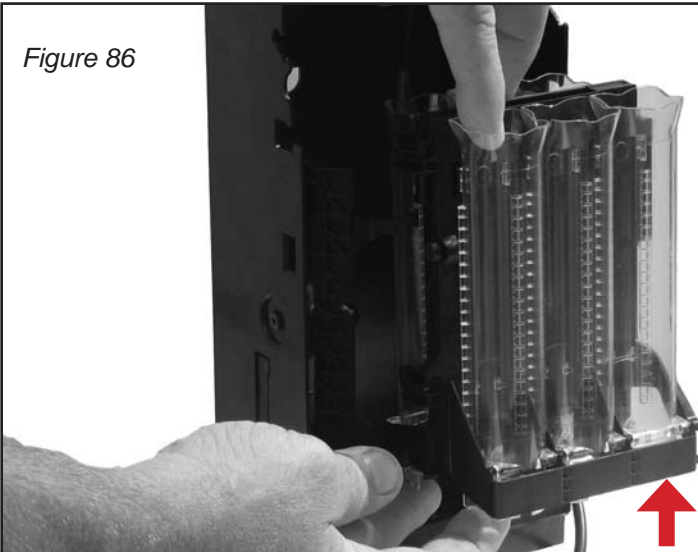

Removing the Coin Tubes from the Cassette

- To remove an individual coin tube, hold the cassette assembly then gently pull the top of the coin tube forward to unsnap the top of the tube. Tilt the top of the tube away from the cassette and lift the tube out. See Figures 87 & 88

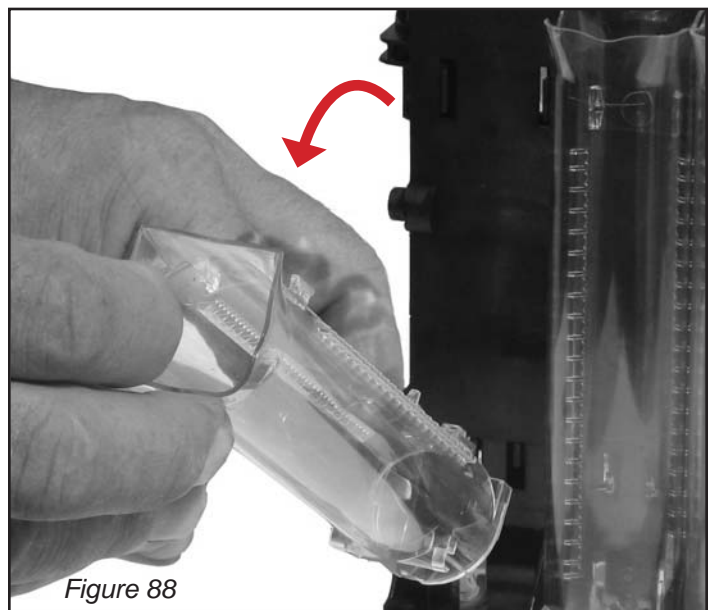
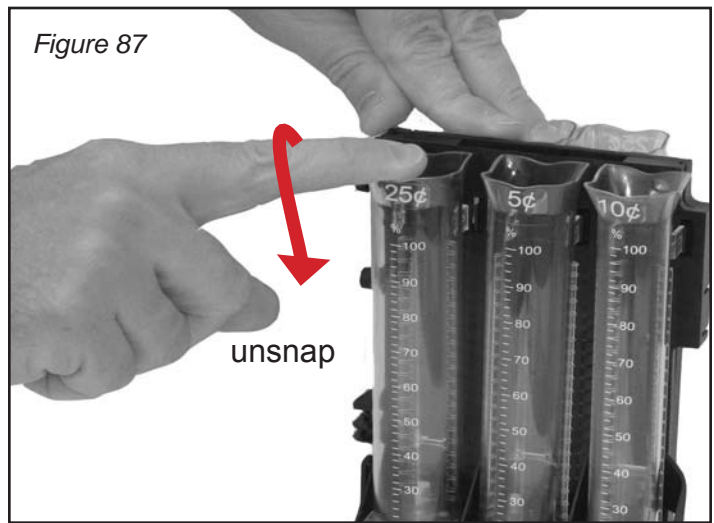

Coin Reject Path

Cleaning the Coin Reject Path

- To access the Coin Reject Path for cleaning, separate the front and back halves of the cassette apart. There is a hinge at the "A/D" tube side of the cassette. Spread the cassette apart at the "C/F" tube side. See Figure 89.

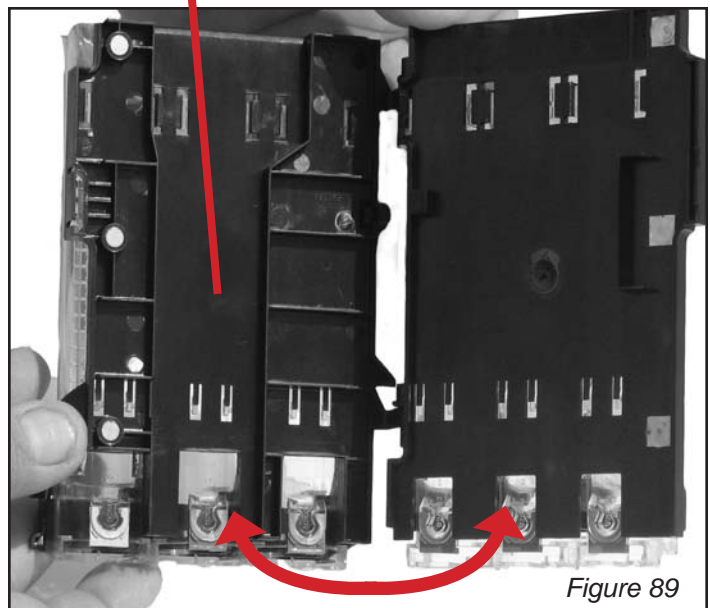

Cleaning the Acceptor

7. To open the Acceptor Gate assembly grab the coin inlet funnel and pivot the gate assembly to the right. Clean the acceptor main plate, inner gate surface and coin ramp. See Figure 90.

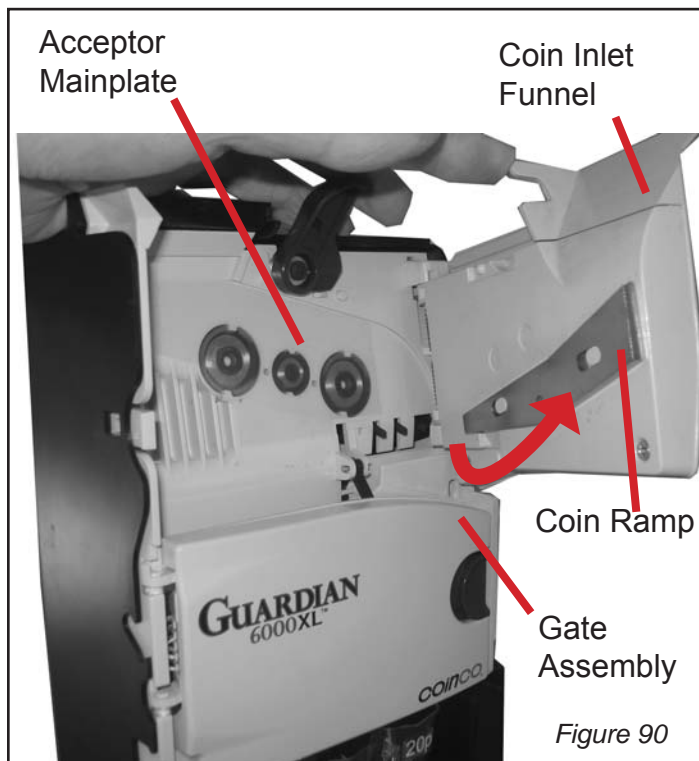

8. Open the acceptor Sorting Door assembly. Slide the Sorting Door Latch to the left and swing the Sorting Door to the left. Clean the inner surface of the front cover assembly. See Figures 91 & 92.

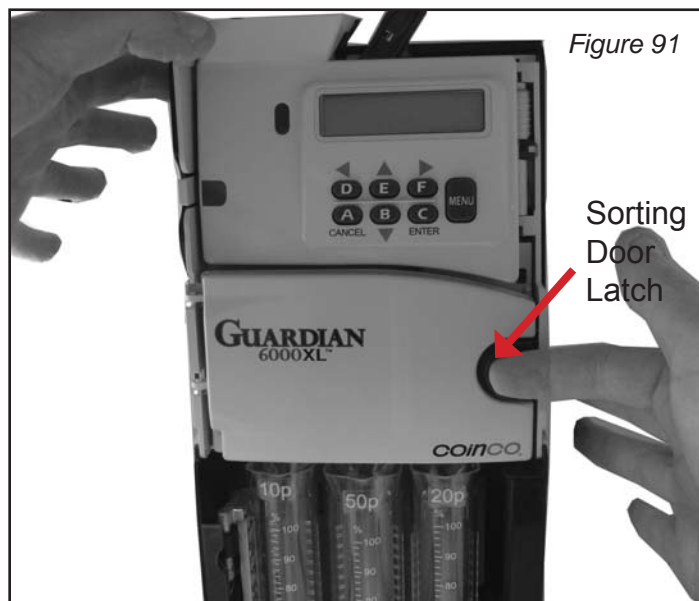

9. Access to the various coin paths for cleaning requires the removal of the clear plastic covers. The Upper Front Cover pivots to the left. Clean both sides of Upper Front Cover. See Figure 92.
10. Remove the Upper Back Cover by pushing its release tab to the right. Lift the upper back cover out of the acceptor. Clean both sides of the Upper Back Cover. See Figure 93.

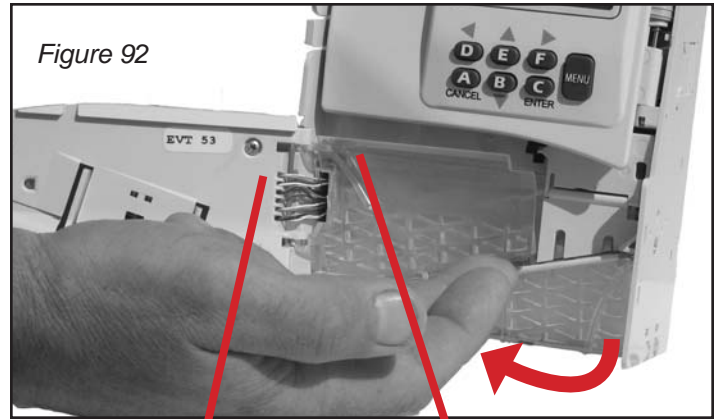

Inner Surface of Sorting Door Assembly
Upper Front Cover

Cleaning the Cashbox Chute

11. Pull the bottom of the cashbox chute out slightly, away from the backside of the changer housing and slide the chute down to release. Twist the chute clockwise to disengage the upper pin. Clean the chute and housing coin path. See Figure 94.
12. If not already done, remove acceptor or pivot it open. Make sure the harness is inserted back into the notch in the front of the cashbox chute. See Figure 95.

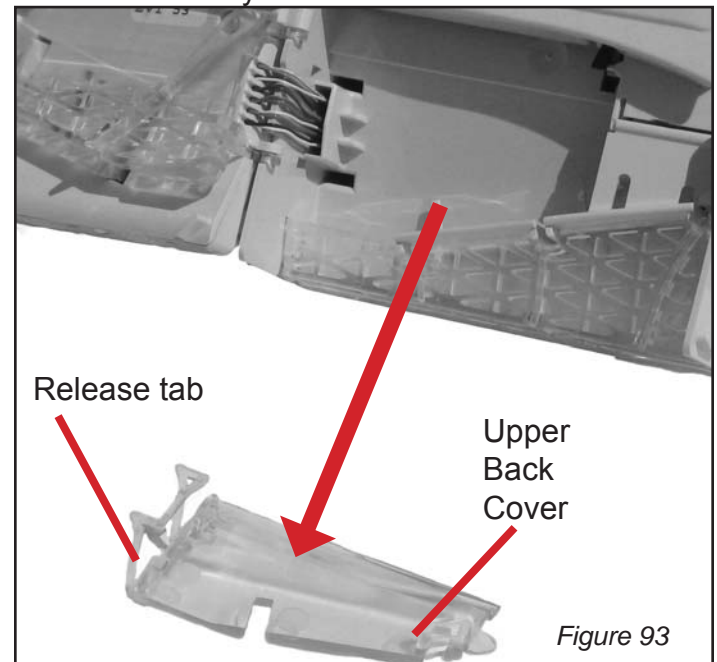

Release tab
Upper Back Cover

Figure 93

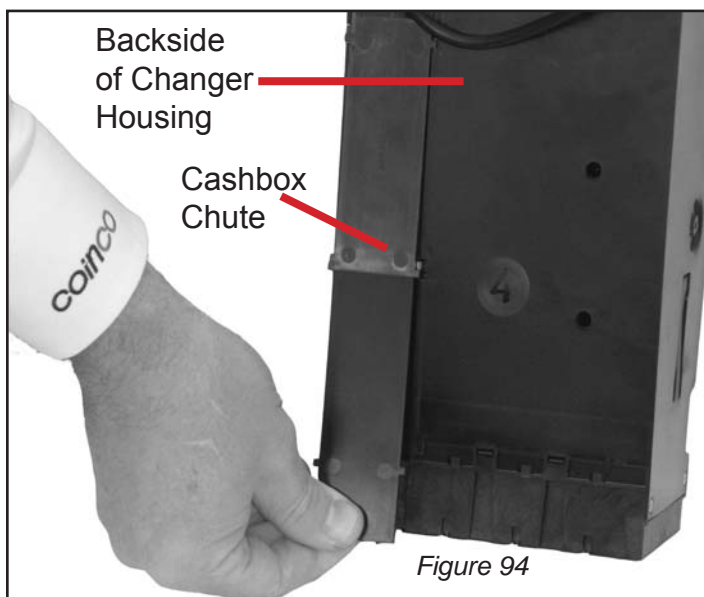

Backside of Changer Housing

Cashbox Chute

Figure 94



Harness Notch

Figure 95

SECTION 8: TROUBLESHOOTING

Troubleshooting

The Guardian 6000XL™ incorporates a range of features to assist the user. These include:

1. Active **audible and visual feedback** to make sure the changer is not inadvertently left in a non-ready state.
2. A changer **Autotest** capability to cycle and verify proper feedback of all changer systems.
3. **Warning** and **Out of Service** messages to notify the user of corrections that should be made.

Guardian 6000XL™ Autotest

Cycles and verifies proper feedback of all changer systems.

The Autotest feature can be used to verify the correct operation of all systems. After being initiated by the user, the changer will cycle each system, and report the status of each on the LCD display as the systems are being cycled.

See Figure 96 for how to initiate the Autotest feature.

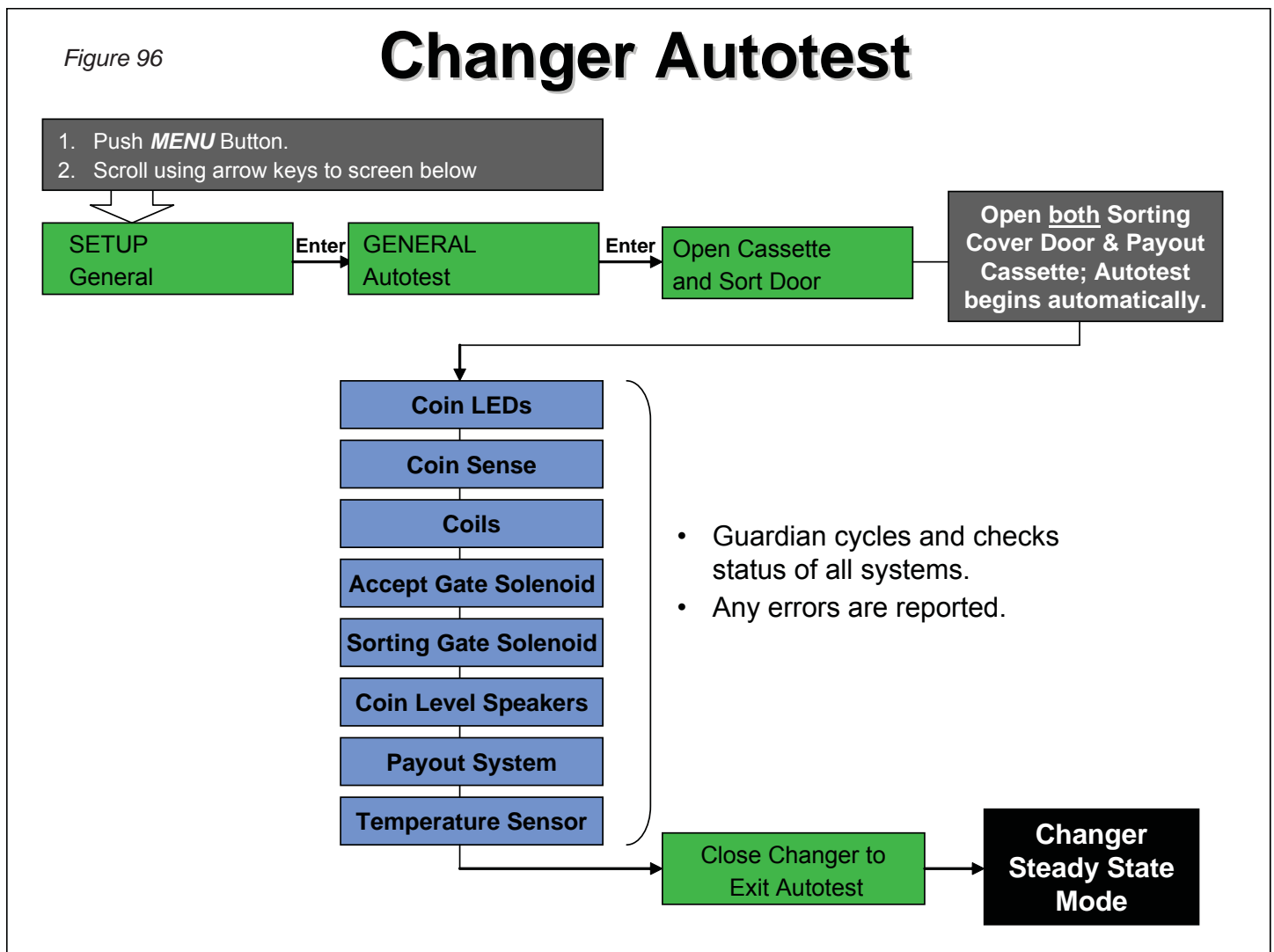

Guardian 6000XL™ Warning Messages

The LCD user interface display notifies the user of any corrections that should be made, or service work to be performed.

The Guardian displays two types of messages:

1. **Warnings:** “soft” errors that are displayed for the user’s information. The changer is and will remain in operation with one or more warnings.
2. **Out Of Service:** a problem that must be corrected. The changer is not operational when this kind of message is displayed.

Figure 98 shows the different types of messages and what each means. All warnings are accompanied by an audible beep if the sound is turned on. See Figure 43 for how to disable / enable audible feedback.

-  **How do I access changer usage data?**
The most useful data is displayed for the user in Audit Reporting. More detailed data is available to authorized Coinco Service Centers for evaluation and troubleshooting.

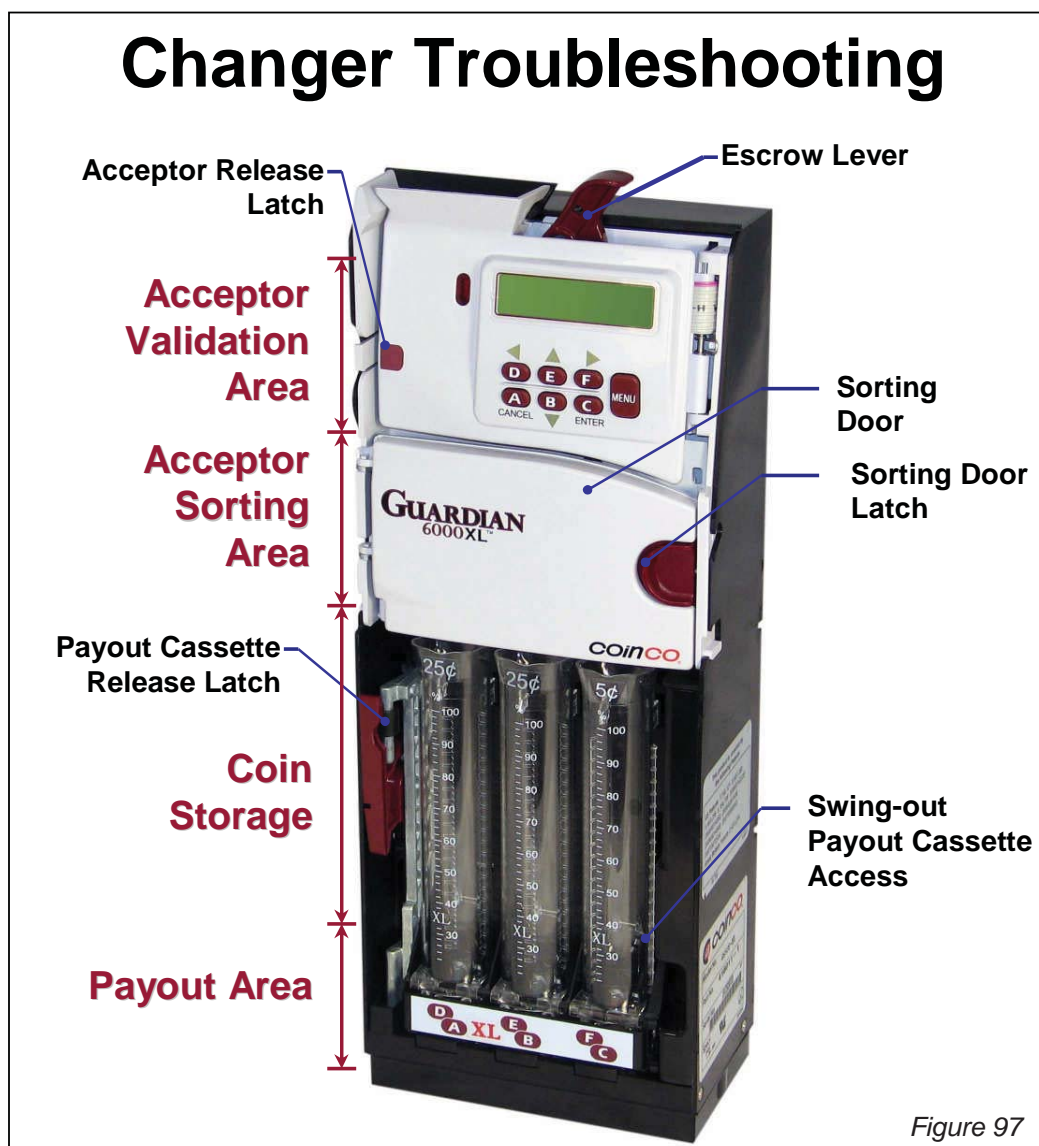

Figure 98

Warning Messages

Display

Check Coin Path

Escrow Detected

Sort Door Open

Cassette Door Open

Payout Jam
Tube X

Tube Sense
Tube X

Low Power

Definition

There is a problem in the Acceptor Validation or Sorting area and these should be checked. Cleaning is most likely required.

The Escrow Lever is depressed enough to open the acceptor gate or there is a jam in the Acceptor Validation area. Please check these areas.

The Sorting Door has not been closed properly.

The Payout Cassette has not been closed properly.

The noted coin tube has had a payout problem. Remove the Payout Cassette, check that tube and the payout drive belt assembly.

The noted coin tube level reading is inaccurate due to some interference. Please check for any obstructions.

Power to the changer has dropped below the recommended MDB power level.

Out Of Service Messages

Out of Service
Payout Motor E3

The Payout Motor is non-operational. Check all harnesses are connected correctly. If still not operational. ***Please take it to a Coinco authorized Service Center for service.***

Out-of-Service
Tube Sense

There are multiple tube sense errors and the changer is not operational. ***Please take it to a Coinco authorized Service Center for service.***

Out-of-Service
Payout Motor

The changer has a Payout Motor problem and is not operational. ***Please take it to a Coinco authorized Service Center for service.***

Manufactured under one or more of the following patents:

- USA: 4,587,984; 4,763,769; 4,838,406; 5,167,314; 5,184,708; 5,460,256; 5,485,908; 5,577,957; 5,579,887; 5,607,350; 5,662,205; 5,673,781; 5,733,186; 6,230,870;
- France: 9302237
- Canada: CA1,223,364 and CA1,281,134
- Germany: DE3410924
- Great Britain: GB2140954
- Italy: IT1263618



For North America:
Coin Acceptors, Inc.
World Headquarters
300 Hunter Avenue
St. Louis, MO 63124-2013
(314) 725-0100 or 1-800-325-2646

For Europe:
Coin Acceptors Europe Ltd.
4 The Felbridge Centre
Imberhorne Lane
East Grinstead, West Sussex
United Kingdom, RH19 1XP
++44 (0)1342 315724

For Australasia:
Coin Acceptors, Inc.
Unit 1, 2 Morton ST
Parramatta, N.S.W.
2150 Australia
02 9890 5433

email: techsupport@coinco.com

www.coinco.com